

Application Manual

Waterproofing & Deck
Coating Systems

December 2020



Table of Contents

Introduction	iv
Project and Substrate Conditions	1
Project Conditions	1
Concrete	1
Plywood	2
Field Sample	2
Surface Preparation	3
Concrete: New Construction	3
Concrete: Remedial Construction	5
Plywood: New Construction	7
Plywood: Remedial Construction	8
Metal Surfaces: Vents, Pipes, Drains, Flashing, Etc.	8
Concrete Moisture Testing	9
Product Mixing	10
System Application	11
Important General Principles	11
Auto-Gard	12
Auto-Gard T	13
Auto-Gard Aliphatic	14
Auto-Gard Aliphatic T	16
Auto-Gard FC	17
Auto-Gard FC Aliphatic	19
Auto-Gard FC T	20
Auto-Gard E	21
Auto-Gard F	22
Peda-Gard	23
Peda-Gard Aliphatic	24
Peda-Gard Aliphatic T	26
Peda-Gard FC	27
Peda-Gard FC T	28
Peda-Gard FC Aliphatic	29

Peda-Gard FR.....	30
Peda-Gard FC Recreational Deck.....	31
Decorative Peda-Gard.....	32
Decorative Peda-Gard FC.....	35
Decorative Peda-Gard Flake.....	37
Decorative Peda-Gard FC Flake.....	38
TrafficTuff	39
Epoxy Broadcast Overlay.....	40
Peda-Gard M.....	42
Peda-Gard TS	43
Peda-Gard FC TS.....	44
Pool-Gard C.....	45
Peda-Gard SC.....	46
Perma-Gard III.....	47
RTS Vehicular.....	48
RTS Pedestrian.....	49
RTS Decorative Flake.....	50
RTS Decorative Quartz.....	52
RTS Helipad.....	53
RTS Under Tile.....	54
RTS Buried Horizontal Waterproofing.....	55
Detail Drawings.....	56
Recoat Guidelines.....	61
Preparing to Recoat.....	61
System Recoat Guidelines.....	62
Field Adhesion Testing.....	64
ASTM D903.....	64
Rag Test.....	65
ASTM D7234 (Concrete Substrates).....	67
ASTM D4541 (Metal Substrates).....	68
Support Information.....	69
Coverage Rates.....	69
Thinning and Cleaning Solvents.....	70
Reading Lot/Batch Numbers.....	71
Primers.....	71
RTS BPO Initiator Dosage Chart.....	74
Additives.....	74

Surface Conditioners for Structural Concrete Decks.....	75
Epoxy Patching.....	75
Weather Impact on Coating Materials.....	76
Dew Point of Moist Air.....	77
Sample Curing Charts.....	78
Safety and Storage.....	80
Glossary.....	85

Introduction

Dear Neogard Customer,

This manual covers many important technical aspects of Neogard waterproofing and deck coating systems. It is intended for personnel who are involved in selling, estimating, administration and application.

We will make changes and additions to this handbook as technology evolves. For specific application questions or technical assistance, contact the Neogard Technical Service Department by phone at (214) 353-1600, or use the contact form at www.neogard.com/contact. Additional technical resources are also available at www.neogard.com.

Thank you for your help in making this manual possible.

Your Neogard Team

Project and Substrate Conditions

Project Conditions

For on-grade applications, substrates constructed over unvented metal decks or split-slab applications, contact the Neogard Technical Service Department for specific project-related recommendations. Concrete mix design and placement, presence of a vapor barrier, environmental factors, and other issues determine the suitability for coating these conditions.

- Prior to starting work, read and follow the Safety Data Sheets (SDS) and container labels for detailed health and safety information.
- Apply materials only when substrate temperature is above 40°F/4°C. Substrate shall be dry, clean, and frost-free. Temperature shall be more than 5°F/3°C above dew point and rising. Do not apply if precipitation or freezing temperatures are imminent. Take special precautions when ambient and/or substrate temperatures are approaching, at, or above 100°F/37°C; if possible, limit application to evening hours for exterior exposed decks.
- Coordinate waterproofing work with other trades. Applicator shall have sole right of access to the specified area for the time needed to complete the application and allow the traffic coatings to cure adequately.
- Protect plants, vegetation or other surfaces not to be coated, against damage or soiling. It is much easier to keep coating off adjacent surfaces during application than to remove it after cure.
- Keep products away from spark or flame. Do use equipment which may produce sparks during application and until all vapors have dissipated. Post “No Smoking” signs.
- Maintain the work area in a neat and orderly condition, removing empty containers, rags and rubbish daily from the site.

Concrete

Verify that the work done under other sections meets the following requirements:

- The concrete deck surface is free of ridges and sharp projections. If metal decks are used, they should be ventilated to permit adequate drainage of any trapped moisture.
- The concrete was cured for a minimum of 28 days. Minimum compressive strength: 3,000 psi for pedestrian traffic, 4,000 psi for vehicular traffic. Water-cured treatment of concrete is preferred. The use of concrete curing agents, if any, shall be of the sodium silicate base only; others require written approval by Neogard.
- Damaged areas of the concrete deck are restored to match adjacent areas. Use 100% solids epoxy and sand for filling and leveling. See “Concrete Patching” in the Surface Preparation section of this manual.
- The concrete was finished by a power or hand steel trowel followed by soft hair broom to obtain light texture or “sidewalk” finish similar to the photo on the following page.

Light texture or sidewalk finish



Plywood

Verify that the plywood deck work done under other sections meets the following requirements:

- Plywood is of exterior grade quality and minimum B-C grade with B side to receive coating. Plywood shall be at least 5/8" thick. Tongue and groove plywood is preferred.
- Joist spacing beneath plywood deck has a maximum spacing of 16" O.C.
- Lay a bead of 70991 polyurethane sealant on the joist, then install the plywood decking immediately on top of the wet sealant.
- Fill plywood imperfections with 70991 polyurethane sealant.
- Use spiral or coated nails and are drive flush with the surface of plywood. Do not countersink nails.
- Maintain a maximum of 1/16" space between sheets of plywood is while deck is being placed.
- Cover plywood decking as soon as possible after installation.

Field Sample

Install a field sample of at least 100 square feet at the project or pre-selected area as agreed to by owner's representative, applicator and manufacturer.

- Apply material in accordance with written application instructions.
- Field sample will be the standard for judging color and texture on remainder of project.
- Maintain field sample during construction for workmanship comparison.
- Do not alter, move, or destroy field sample until work is completed and approved by Owner's representative.

Surface Preparation

Concrete: New Construction

General Construction Practices

- Surfaces to receive Auto-Gard systems must be a minimum compressive strength of 4,000 psi.
- Surfaces to receive Peda-Gard systems must be a minimum compressive strength of 3,000 psi.
- Insulating concrete—Zonolite, Vermiculite, Perlite, or others—must never be coated directly with surface applied waterproofing.
- Concrete must have a full 28-day cure period prior to coating.

Finish Requirements

- The deck must be steel troweled with power or hand trowel. Finish concrete by lightly pulling a soft hair broom over the surface to leave a light texture. No projections or voids should be present in the concrete surface.
- If the concrete finish is rougher or smoother than a light hair broom finish, consult Neogard for additional surface preparation procedures.
- Water curing of deck is the preferred method. However, if a curing compound is to be used, it must be of the sodium silicate type. Other types of curing compounds require prior written approval by Neogard. Chlorinated rubber, wax or resin based curing compounds must not be used.
- Deck must be free from contaminants such as oils, tars, asphalts, grease, dirt, etc., prior to coating.

Methods for Preparing Concrete Deck

Shot-Blasting

Shot-blasting is the preferred method to remove laitance from concrete surfaces. Take care and use proper procedures to leave the concrete surface as unopened as possible. Shot-blasting is also preferred over sandblasting to remove an unacceptable curing compound. Mechanically prepare surface by shot-blasting to industry standard surface texture—ICRI CSP3 or CSP4—without causing additional surface defects in deck surface. See the example photos below.

Note: Shot-blasting does not remove deep penetrating oils, grease, tar or asphalt stains. Proper cleaning procedures should be followed to ensure proper bonding of the deck coating.

ICRI CSP3



ICRI CSP4



- Improper shot-blasting can destroy the surface finish of the concrete. Overly-blasted concrete can contain voids or pinholes which can result in blister problems during coating application. It may also require extra coats of additional material to correctly “profile” the rough surface.

Important: The coverage rates for Neogard traffic deck coatings are for a properly prepared concrete deck. Deficiencies will reduce the effective coverage rate of the materials.

Hydro-Blasting (Pedestrian Systems Only)

If shot-blasting is not practical, hydro-blasting is an alternative method of surface preparation for a concrete substrate that will receive a pedestrian traffic-bearing system.

- Use a minimum of 4,000 psi spray at tip, within 6” of substrate to prepare surface by hydro-blasting to industry standard surface texture (CSP3–CSP4) without causing additional surface defects in deck.
- Rinse thoroughly to ensure all residue is removed from the surface.
- Allow deck to completely dry prior to application of deck coating materials.

Sandblasting

Sandblasting is recommended only as a last resort, after shot-blasting or when necessary to remove an unacceptable curing compound.

- Sandblasting can cause “pinholes” in concrete surfaces which could cause blister problems during coating application and in the finished system.
- Can be used to remove incompatible striping paint from deck prior to application of surface applied waterproofing.

Sandblast Pot



Concrete Patching

Very few repairs should be necessary in new concrete if the slab is placed according to specifications, but minor imperfections must be corrected. There are many projects that the applicator is contracted to do after the structure is complete and the decks were improperly finished, not anticipating the use of a surface applied waterproofing system.

- Ridges and sharp projections should be ground off and pits, holes and low spots should be filled with 70714/70715 series epoxy and sand mixture at a ratio of one part epoxy to four parts sand in accordance with the “Epoxy Patching” and “Surface Conditioners for Structural Concrete Decks” sections of this Application Manual. See the example photos shown below. The repairs should be done after any chemical cleaning, and the epoxy patch allowed to cure approximately one day at 75°F/23°C–80°F (26°C).
- One gallon of mixed epoxy mixed with four gallons of 20-40 mesh clean, dry sand will yield approximately 6.42 square feet of epoxy patching material at one inch thickness.

Pit in concrete



Pit patched with epoxy and sand



Cracks and Cold Joint Preparation

- Visible hairline cracks (up to 1/16" in width) in concrete and cold joints shall be cleaned, primed and treated with polyurethane deck coating material extended a minimum distance of 2" on either side of crack to yield thickness of 30 dry mils.
- Large cracks (over 1/16" in width) shall be routed, blown clean, and filled flush with 70991 polyurethane sealant. Sealant shall be applied to inside area of crack only, not applied to deck surface. After sealant has cured, detail sealed cracks with polyurethane Base Coat material extended a minimum distance of 2" on either side of crack to yield thickness of 30 dry mils. **Note: Cured sealant must be solvent wiped. Allow solvent to flash off prior to installation of Base Coat detail stripe.**

Control Joint Preparation

- Seal control joints equal to or less than 1" in width with 70991 polyurethane sealant. Be sure to maintain proper ratio of width to depth. After the sealant has cured, detail sealed joints with polyurethane Base Coat material extended a minimum distance of 2" on either side of joint to yield thickness of 30 dry mils. Preparation and treatment of joints > 1" in width is beyond the scope of this Application Manual and an expansion joint manufacturer should be consulted for those applications.

Note: Cured sealant must be solvent wiped. Allow solvent to flash off prior to installation of Base Coat detail stripe.

Concrete: Remedial Construction

General Construction Practices

- Surfaces to receive Auto-Gard systems must be a minimum compressive strength of 4,000 psi.
- Surfaces to receive Peda-Gard systems must be a minimum compressive strength of 3,000 psi.
- Insulating concrete—Zonolite, Vermiculite, Perlite, or others—must never be coated directly with surface applied waterproofing.
- Concrete patches must have a full 28-day cure period prior to coating.
- Surfaces must be sound and dry. Remove all delaminated or scaled concrete, paint, tar, asphalt, grease, dirt, waxes, oils, etc., as may be necessary to establish a clean, dry substrate.

Finish Requirements

- Existing deck should have the same finish as a new deck. No projections or voids should be present in the concrete surface.
- If the concrete finish is rougher or smoother than a light hair broom finish, consult Neogard for additional surface preparation procedures.
- Water curing of structural concrete patches is the preferred method. However, if a curing compound is to be used, it must be of the sodium silicate type. Other types of curing compounds require prior written approval by Neogard. Chlorinated rubber, wax or resin based curing compounds must not be used.
- Deck must be free from contaminants such as oils, tars, asphalts, grease, dirt, etc., prior to coating. Solvent based products are incompatible with asphaltic compounds.

Methods for Preparing Existing Concrete Deck

- Deck should be cleaned using Neogard 8500 BioDegradable Cleaner concentrate with water, and stiff bristle brooms or a power scrubber. Completely rinse away residue. Scrub solution with stiff bristle broom and allow to stand for approximately 15 minutes. Do not allow the solution to dry. Thoroughly rinse to remove all residue.

- Heavily contaminated areas may require mechanical grinding or chipping before washing.
- Shot-blast, acid etch or sandblast deck as follows:

Shot-Blasting (Preferred for Remedial Application)

- Proper care and procedure should be taken to leave the concrete surface as unopened as possible. Shot-blasting is the preferred method to remove unacceptable curing compounds. Mechanically prepare surface by shot-blasting to industry standard surface texture (CSP3 or CSP4) without causing additional surface defects in deck surface.
- Improper shot-blasting may cause “pinholes” in concrete surfaces which can result in blister problems during coating application and in the finished system.
- Shot-blasting will not remove projections on surface of concrete. These should be ground off prior to coating application.

Note: Shot-blasting does not remove deep penetrating oil, grease, tar or asphalt stains. Proper cleaning procedures should be followed to ensure proper bonding of the deck coating.

Hydro-Blasting (Alternative preparation ONLY for concrete receiving pedestrian systems)

- If shot-blasting is not practical, hydro-blasting is an alternative method of surface preparation for a concrete substrate that will receive a pedestrian traffic-bearing system.
- Use a minimum of 4,000 psi spray at tip, within 6” of substrate to prepare surface by hydro-blasting to industry standard surface texture (CSP3 or CSP4) without causing additional surface damage.
- Proper cleaning procedures must be followed to ensure bonding of the deck coating. Rinse thoroughly to ensure all residue is removed from the surface.
- Allow deck to completely dry prior to application of deck coating materials.

Sandblasting

- Sandblasting is recommended only as a last resort, or to remove an unacceptable curing compound.
- Sandblasting can cause “pinholes” in concrete surfaces which could cause blister problems during coating application and in the finished system.
- Sandblasting can be used to remove incompatible striping paint from deck prior to application of surface applied waterproofing.

Concrete Patching and Concrete Replacement

- Patching of concrete in remedial applications is usually required. Ridges and sharp projections should be ground off and pits, holes and low spots should be filled with 70714/70715 series epoxy and sand mixture at a ratio of one part epoxy to four parts sand in accordance with the “Epoxy Patching” and “Surface Conditioners for Structural Concrete Decks” sections of this Application Manual. The repairs should be done after any chemical cleaning, and the epoxy patch allowed to cure approximately one day at 75°F/23°C to 80°F/26°C.
- One gallon of mixed epoxy mixed with four gallons of 20-40 mesh clean dry sand will yield approximately 6.42 square feet of epoxy patching material at one inch thickness.

Cracks and Cold Joint Preparation

- Visible hairline cracks (up to 1/16” in width) in concrete and cold joints shall be cleaned, primed and treated with polyurethane Base Coat material extended a minimum distance of 2” on either side of crack to yield thickness of 30 dry mils.
- Large cracks (over 1/16” in width) shall be routed, blown clean, and filled flush with 70991 polyurethane sealant. Sealant shall be applied to inside area of crack only, not applied to deck surface. After sealant

has cured, detail sealed cracks with polyurethane Base Coat material extended a minimum distance of 2" on either side of crack to yield thickness of 30 dry mils.

Note: Cured sealant must be solvent wiped. Allow solvent to flash off prior to installation of Base Coat detail stripe.

For RTS PMMA/PUMA Systems:

- Moving Cracks: Apply 100 PMMA Concrete and Metal Primer (256JB) and fill with 200 Membrane (870JB).
- Non-Moving Cracks: Apply 100 PMMA Concrete and Metal Primer and fill with 300 Flexible Body Coat (871JB).
- Strike coating flush with adjacent surfaces.

Control Joint Preparation

- Seal control joints equal to or less than 1" in width with 70991 polyurethane sealant. Be sure to maintain ratio of width to depth. After sealant has cured, detail sealed cracks with polyurethane Base Coat material extended a minimum distance of 2" on either side of crack to yield thickness of 30 dry mils. Preparation and treatment of joints > 1" in width is beyond the scope of this Application Manual and an expansion joint manufacturer should be consulted for those applications.

Note: Cured sealant must be solvent wiped. Allow solvent to flash off prior to installation of Base Coat detail stripe.

Plywood: New Construction

General Construction Practices

- Plywood should be minimum B-C exterior grade and a minimum of 5/8" thickness with joist spacing 16" on center. "B" side to be exposed to receive the coating system.
- Nails should not be countersunk, but simply nailed flush.
- Nails used should be spiral or "non-backing" nails (coated).
- A joint of 1/16" to 1/8" should be left between sheets. Tongue and groove plywood is available with 1/16" joint built in.
- It is recommended that a bead of 70991 polyurethane sealant be laid on the joist with the plywood decking installed immediately on top of the wet sealant.
- Plywood imperfections are filled flush with 70991 polyurethane sealant.
- Pressure treated or "Wolmanized" plywood requires a six month aging period to allow proper adhesion

Joint Preparation

- Joints at changes in plane or expansion details should be detailed with 86218 flashing tape. Joints should be caulked flush with 70991 polyurethane sealant and detailed with polyurethane Base Coat material with 86220 Tietex reinforcement fabric embedded into wet coating. Extend detail coat a minimum distance of 3" on either side of joint. Apply additional Base Coat material as required to fully encapsulate fabric and smooth out wrinkles. **Note: Cured sealant must be solvent wiped. Allow solvent to flash off prior to installation of Base Coat detail stripe.**

(continued on next page)

Plywood: Remedial Construction

General Construction Practices

- Ensure joint spacing, nailing methods, etc. are consistent with or exceed general construction practices for new plywood. Consult Neogard Technical Services if this is not the case and cannot be readily corrected.
- Existing plywood decks must be absolutely clean and free of dust, oil, asphalt, grease, and old paint. This can usually be done with a floor sander. Lift all debris with a vacuum.
- Plywood imperfections are filled flush with 70991 polyurethane sealant.

Joint Preparation

- Joints at changes in plane or expansion details should be detailed with 86218 Flashing Tape. Joints should be caulked flush with 70991 polyurethane sealant and detailed with polyurethane Base Coat material with 86220 Tietex reinforcement fabric embedded in wet coating. Extend detail coat a minimum distance of 3" on either side of joint. Apply additional Base Coat material as required to fully encapsulate fabric and smooth out wrinkles.
- Cured sealant must be solvent wiped. Allow solvent to flash off prior to installation of Base Coat detail stripe.

Metal Surfaces: Vents, Pipes, Drains, Flashing, Etc.

Ferrous Metal (Carbon Steel)

- Surface must be wire brushed, ground with wire wheels or sandblasted to a near-white metal blast finish. This is the removal of all visible rust, mill scale, paint and other foreign matter from the surface.
- Prime metal with Ureprime HS4 according to procedures recommended by Neogard.

Galvanized Steel and Other Non-Ferrous Metals

- Remove dust and dirt by blowing off the surface with high pressure (oil-free) air or wiping with clean dry rags. Oil, grease and protective mill coatings should be removed by solvent cleaning. White rust should be removed from galvanized steel by hand or power brushing. Care should be taken not to damage or remove the galvanizing. Rust should be removed from old galvanized steel by hand or power tool cleaning.
- Prime metal with Ureprime HS4 according to procedures recommended by Neogard.

Concrete Moisture Testing

New concrete should not be coated for at least 28 days to permit the concrete to cure and dry out. All slab-on-grade applications should be tested to determine if excessive moisture vapor is being transmitted through the slab. Free water and soluble alkaline salts remaining in the concrete may attack fresh coatings and/or eventually cause delamination, blistering, peeling or efflorescence staining.

Concrete should be tested for moisture content before coating. While there is no fully reliable method for determining if concrete is dry enough to coat, there are several test methods that can be performed prior to the installation of a deck coating system to check for levels of moisture in the concrete substrate. Note that the feel or appearance of the surface can be highly deceiving. The ASTM D4263 method described below is used for testing substrates to receive deck coatings. Neogard recommends ASTM test procedures.

ASTM D4263 Plastic Sheet Test Method

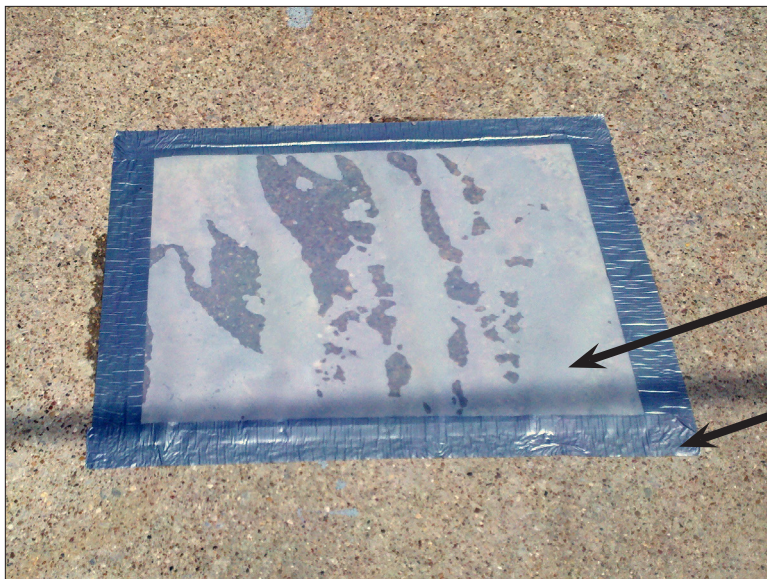

Heavy Gauge Clear Plastic

Duct Tape

- Securely tape a 4 ft. x 4 ft. sheet of clear polyethylene film to the surface as shown in Example 6 above. The plastic film will act as a moisture barrier and trap any moisture migrating through the concrete. The tape will prevent the escape of any moisture or vapor that is trapped behind the film. Carefully apply the tape to prevent any trapped moisture or vapor from escaping.
- Keep the film in place for 24 hours. The test area must be kept shaded for duration of test per ASTM procedures.
- Condensation on the back side of the film, or dark, damp or wet concrete under the film indicates the presence of moisture in the concrete as demonstrated in Example 6 above. If the test area shows there is moisture, do not proceed with coating application until the concrete is re-tested and the test shows it to be dry.
- Pieces of test film should be placed at various locations that are likely to be slow drying out, such as below grade, low spots in deck, inside corners and lower wall areas.

Product Mixing

Use a low-to-medium speed drill and a Jiffy Mixer, shown at right, to mix all materials thoroughly. Mixing at high speed or with the wrong mixer can introduce air bubbles into the coating. These bubbles may develop into blisters during application.

Jiffy Mixer



Note: If a film of cured material is found on the top of the coating product when opened, remove the film. NEVER mix cured material into coating.

Single Component Polyurethane Coatings

Read Product Data Sheets and container labels prior to mixing materials.

Thin materials only after they are mixed. Thin materials by at most 10%. See “Thinning and Cleaning Solvents” in the Support Information section of this Application Manual.

Read instructions for using accelerators in “Additives” in the Support Information section of this Application Manual.

Two-Part Polyurethane Coatings or Epoxies

Caution: Two-component materials must be mixed thoroughly.

Check the product's mix ratio on container labels, Product Data Sheets, and in this Application Manual prior to mixing materials. Proper ratios are essential for coating performance and development of physical properties. Off-ratio materials will improperly cure and not meet their physical specifications.

The curing agent—sometimes called the catalyst or B-side—is always to be added to the base. Never add the base to the curing agent; the materials will not mix properly.

Mix the base thoroughly for 3–5 minutes before adding the curing agent. This ensures proper color distribution.

Once the base and curing agent are combined, mix them together. Mix 5-gallon or smaller buckets for a minimum of 5 minutes, and 55-gallon drums for a minimum of 20 minutes.

Thin two-part materials only after they are mixed. If materials are thinned prior to mixing, proper coating ratios will not be achieved. Thin materials by at most 10%. See “Thinning and Cleaning Solvents” in the Support Information section of this Application Manual.

When pumping a two-part polyurethane through plural-component equipment, be sure to thoroughly mix the base prior to pumping. Thinning must be done equally to both the base and curing agent prior to spraying.

RTS Products

Add the appropriate dosage of Neogard 600 RTS BPO Initiator to all materials and mix thoroughly before applying. Refer to the RTS BPO Initiator Dosage Chart in the Support Information section of this Application Manual for the correct amounts. An RTS BPO Initiator Dosage Chart is also available on Neogard PMMA/PUMA Product Data Sheets.

System Application

Important General Principles

Important: Applicator is responsible for applying sufficient coating to the substrate.

Note: Prior to application, refer to the Product Mixing Instructions section in this Application Manual.

- Never coat wet or moist surfaces with urethane materials. If in doubt, perform a moisture test.
- Urethane products are incompatible with asphalt compounds.
- It is much easier to keep coating off an adjacent surface during application than to remove it after cure.
- Flush equipment lines thoroughly every night to prevent material from clogging hoses.
- In systems requiring the use of primers, coating materials should be applied the same day as priming.
- When placing two-component (2k) materials, never turn empty pails upside down or scrape sides to capture remaining coating. This material is not fully mixed and will result in uncured areas of coating.
- Always segregate topcoat material by batch number and avoid using different batch numbered material in continuous expanses. If you don't have enough material from the same batch number to complete the final topcoat application, box the material. Neogard cannot guarantee absolute color consistency between batches.

Factors That Affect Dry Film Thickness

Many factors can affect the amount of wet coating required to yield proper dry film thickness, including: Volume of solids; thinning; surface profile; application technique and equipment; overspray; squeegee; brush and roller wet out; container residue; spills and other waste.

To ensure that specified dry film thickness is achieved, use a wet mil gauge to check thickness of wet coating applied, adjusting as needed for those factors which directly affect the dry film build.

Utilize an optical comparator to verify actual dry film thickness and adjust coverage rates accordingly.

Note: System application instructions are for horizontal surfaces. Vertical or inclined surfaces may require additional coats to build film to design thickness.

Coating Phase Termination

Terminate phases at joints. This will provide a neat break and will offer the best aesthetics when project application is completed. Use the same batch number of topcoat material for all phases of the project.

- At Joint: bring current coating on to urethane joint sealant and end on sealant. When continuing coating application, clean and solvent wipe existing coating, apply primer (as needed) and follow with coating system.
- Mid-Slab: Apply tape or similar material to terminate current application in a straight line. Leave base coat exposed by stopping wear/topcoat application 4"–6" from termination point. Do not leave base coat exposed for more than 5 days. When proceeding with application, clean and solvent wipe exposed base coat. Apply wear coat to existing wear coat. Overlap neat topcoat to existing finished system. If using seed and backroll application method, overlap on existing system approximately 4".

Note: If base coat will not be coated within 5 days, terminate full system at straight line. When proceeding, clean and solvent wipe existing system approximately 4”–6” and overlap new system over existing system.

Auto-Gard

Materials

- Primers: 7760/7761 (25100), 7780/7781 (280JB), or 7797/7798 (254JB).
- Aggregate: 7992 (66010) silica quartz sand.
- Base Coat: 70410 (45010) urethane.
- Wear Coat: 7430 (57040) series urethane.
- Topcoat: 7430 (57040) series urethane.

Note: For lower odor, use 7780/7781 or 7797/7798 primer.

Average Dry Film Thickness

- Standard system: 40 dry mils (excluding primer and aggregate).
- Heavy duty in high wear areas (turns, ramps, ticket spitters, etc.): 52 dry mils (excluding primer and aggregate).

Application Instructions

Seed and Lock Method

1. Primer: Thoroughly mix and apply selected primer and apply at a rate of 300 sf/gal (0.33 gal/100 sf) and allow to cure. 7797/7798 may be applied at up to 500 sf/gal (0.2 gal/100 sf).
2. Base Coat: Thoroughly mix and apply 70410 at 60 sf/gal (1.66 gal/100 sf or 26 wet mils) to yield 20 dry mils and allow to cure. The Base Coat must be applied within 24 hours of priming, otherwise clean deck and re-prime as outlined above. Note: Do not leave base coat exposed for more than 5 days.
3. Wear Coat: Thoroughly mix and apply 7430 series at 150 sf/gal (0.66 gal/100 sf or 10 wet mils) to yield 8 dry mils and immediately broadcast 7992 aggregate, evenly distributed, into wet coating at a rate of 15 lbs/100 sf and allow to cure. Remove loose aggregate by blowing, sweeping or vacuuming.
4. Heavy Duty Areas (turns, ramps, ticket spitters, etc.): Note: For parking stalls and non-heavy duty service, skip this step and proceed to the next item. After removing loose aggregate from Wear Coat, thoroughly mix and apply a second Wear Coat of 7430 series at 100 sf/gal (1.0 gal/100 sf or 16 wet mils) to yield 12 dry mils, and immediately broadcast 7992 aggregate, evenly distributed, into wet coating at a rate of 10 lbs/100 sf and allow to cure. Remove loose aggregate by blowing, sweeping, or vacuuming.
5. Topcoat: Thoroughly mix and apply 7430 series at 100 sf/gal (1.0 gal/100 sf or 16 wet mils) to yield 12 dry mils and allow to cure.
6. Do not allow traffic on coated surfaces for at least 72 hours at 75°F/23°C, 50% relative humidity.

Summary Application Table

Coat	Product	Mix Ratio	Coverage Rate	Mils WFT/DFT	Recoat Time at 75° F/23° C
Primer	7760/7761	1:1	300 sf/gal	NA	1.5–2 hours
	7780/7781	4:1	300 sf/gal		1.5–2 hours
	7797/7798	2:1	300–500 sf/gal		5–6 hours

Coat	Product	Mix Ratio	Coverage Rate	Mils WFT/DFT	Recoat Time at 75°F/23°C
Base Coat	70410	NA	60 sf/gal	26 WFT/20 DFT	14 hours
Wear Coat Aggregate	7430 series 7992	NA	150 sf/gal 15 lbs/100 sf	10 WFT/8 DFT	12 hours
HD Wear Coat Aggregate	7430 series 7992	NA	100 sf/gal 10 lbs/100 sf	16 WFT/12 DFT	12 hours
Topcoat	7430 series	NA	100 sf/gal	16 WFT/12 DFT	12 hours

Seed and Backroll Method

1. Primer: Thoroughly mix and apply selected primer and apply at a rate of 300 sf/gal (0.33 gal/100 sf) and allow to cure. 7797/7798 may be applied at up to 500 sf/gal (0.2 gal/100 sf).
2. Apply Base Coat of 70410 at 60 sf/gal (1.66 gal/100 sf or 26 wet mils) to yield 20 dry mils, and allow to cure. The Base Coat must be applied within 24 hours of priming, otherwise clean deck and re-prime as outlined above. Note: Do not leave base coat exposed for more than 5 days.
3. Heavy Duty Areas (turns, ramps, ticket spitters, etc.): Note: For parking stalls and non-heavy duty service, skip this step and proceed to the next item. Apply Wear Coat of 7430 series at 100 sf/gal (1.0 gal/100 sf or 16 wet mils) to yield 12 dry mils, and immediately broadcast 7992 aggregate, evenly distributed, into wet coating at a rate of 10 lbs/100 sf and allow to cure. Remove loose aggregate by blowing, sweeping, or vacuuming.
4. Apply Topcoat of 7430 series at 60 sf/gal (1.66 gal/100 sf or 26 wet mils) to yield 20 dry mils, and immediately broadcast 7992 aggregate, evenly distributed, into wet coating at a rate of approximately 15 lbs/100 sf and backroll to encapsulate aggregate. Allow to cure.
5. Do not allow traffic on coated surfaces for at least 72 hours at 75°F/23°C, 50% relative humidity.

Summary Application Table

Coat	Product	Mix Ratio	Coverage Rate	Mils WFT/DFT	Recoat Time at 75°F/23°C
Primer	7760/7761 7780/7781 7797/7798	1:1 4:1 2:1	300 sf/gal 300 sf/gal 300–500 sf/gal	NA	1.5–2 hours 1.5–2 hours 5–6 hours
Base Coat	70410	NA	60 sf/gal	26 WFT/20 DFT	14 hours
HD Wear Coat Aggregate	7430 series 7992	NA	100 sf/gal 10 lbs/100 sf	16 WFT/12 DFT	12 hours
Topcoat Aggregate	7430 series 7992	NA	60 sf/gal 15 lbs/100 sf	26 WFT/20 DFT	12 hours

Auto-Gard T

Materials

- Primers: 7760/7761 (25100), 7780/7781 (280JB), or 7797/7798 (254JB).
- Base Coat: 70410 (45010) urethane.
- Heavy Duty Wear Coat: 70420 (47HJB) integrally textured urethane.
- Topcoat: 70420 (47HJB) integrally textured urethane.

Note: For lower odor, use 7780/7781 or 7797/7798 primer.

(continued on next page)

Average Dry Film Thickness

- Standard system: 40 dry mils (excluding primer).
- Heavy duty in high wear areas (turns, ramps, ticket spitters, etc.): 52 dry mils (excluding primer)

Application Instructions

1. Primer: Thoroughly mix and apply selected primer and apply at a rate of 300 sf/gal (0.33 gal/100 sf) and allow to cure. 7797/7798 may be applied at up to 500 sf/gal (0.2 gal/100 sf).
2. Base Coat: Thoroughly mix 70410 base coat material and apply at a rate of 60 sf/gal (1.66 gal/100 sf or 26 wet mils) to yield 20 dry mils. Extend base coat over cracks and control joints which have received detail treatment.

Note: Do not dip and roll 70420 from container.

3. Double Texture: For heavy duty traffic areas such as ticket booths, spiral ramps, turn areas, or in other areas subjected to extremely high traffic abrasion, apply double texture. In such areas, thoroughly mix 70420 and apply at a rate of 90–100 sf/gal (1.1–1.0 gal/100 sf). Use a 1/8" notched squeegee and 3/8"-1/2" nap roller cover to uniformly backroll prior to applying topcoat.
4. Topcoat: Thoroughly mix 70420 and apply at a rate of 60 sf/gal (1.66 gal/100 sf or 26 wet mils) using a 1/8" notched squeegee and 3/8"-1/2" nap roller cover to uniformly backroll topcoat. Topcoat should be backrolled two times, one perpendicular to the other.
5. Do not allow traffic on coated surfaces for at least 24 hours at 75°F/23°C and 50% relative humidity.

Summary Application Table

Coat	Product	Mix Ratio	Coverage Rate	Mils WFT/DFT	Recoat Time at 75° F/23° C
Primer	7760/7761	1:1	300 sf/gal	NA	1.5–2 hours
	7780/7781	4:1	300 sf/gal		1.5–2 hours
	7797/7798	2:1	300–500 sf/gal		5–6 hours
Base Coat	70410	NA	60 sf/gal	26 WFT/20 DFT	14 hours
Double Texture	70420	NA	90–100 sf/gal	16 WFT/12 DFT	12 hours
Topcoat	70420	NA	60 sf/gal	26 WFT/20 DFT	12 hours

Auto-Gard Aliphatic

Materials

- Primers: 7760/7761 (25100), 7780/7781 (280JB), or 7797/7798 (254JB).
- Aggregate: 7992 (66010) silica quartz sand.
- Base Coat: 70410 (45010) urethane.
- Wear Coat: 7430 (57040) series urethane.
- Topcoat: 7470 (47LJB) series aliphatic urethane.

Note: For lower odor, use 7780/7781 or 7797/7798 primer.

Average Dry Film Thickness

- Standard system: 40 dry mils (excluding primer and aggregate).
- Heavy duty in high wear areas (turns, ramps, ticket spitters, etc.): 52 dry mils (excluding primer and aggregate).

Application Instructions

Seed and Lock Method

1. Primer: Thoroughly mix and apply selected primer and apply at a rate of 300 sf/gal (0.33 gal/100 sf) and allow to cure. 7797/7798 may be applied at up to 500 sf/gal (0.2 gal/100 sf).
2. Base Coat: Thoroughly mix and apply 70410 series at 60 sf/gal (1.66 gal/100 sf or 26 wet mils) to yield 20 dry mils and allow to cure. The Base Coat must be applied within 24 hours of priming, otherwise clean deck and re-prime as outlined above. Note: Do not leave base coat exposed for more than 5 days.
3. Wear Coat: Thoroughly mix and apply 7430 series at 150 sf/gal (0.66 gal/100 sf or 10 wet mils) to yield 8 dry mils and immediately broadcast 7992 aggregate, evenly distributed, into wet coating at a rate of 15 lbs/100 sf and allow to cure. Remove loose aggregate by blowing, sweeping or vacuuming
4. Heavy Duty Areas (turns, ramps, ticket spitters, etc.): Note: For parking stalls and non-heavy duty service, skip this step and proceed to the next item. Thoroughly mix and apply a second Wear Coat of 7430 series at 100 sf/gal (1.0 gal/100 sf or 16 wet mils) to yield 12 dry mils and immediately broadcast 7992 aggregate, evenly distributed, into wet coating at a rate of 10 lbs/100 sf and allow to cure. Remove loose aggregate by blowing, sweeping or vacuuming.
5. Topcoat: Thoroughly mix and apply 7470 series at 100 sf/gal (1.0 gal/100 sf or 16 wet mils) to yield 12 dry mils and allow to cure.
6. Do not allow traffic on coated surfaces for at least 72 hours at 75°F/23°C, 50% relative humidity.

Summary Application Table

Coat	Product	Mix Ratio	Coverage Rate	Mils WFT/DFT	Recoat Time at 75° F/23° C
Primer	7760/7761	1:1	300 sf/gal	NA	1.5–2 hours
	7780/7781	4:1	300 sf/gal		1.5–2 hours
	7797/7798	2:1	300–500 sf/gal		5–6 hours
Base Coat	70410	NA	60 sf/gal	26 WFT/20 DFT	14 hours
Wear Coat Aggregate	7430 series 7992	NA	150 sf/gal 15 lbs/100 sf	10 WFT/8 DFT	12 hours
HD Wear Coat Aggregate	7430 series 7992	NA	100 sf/gal 10 lbs/100 sf	16 WFT/12 DFT	12 hours
Topcoat	7470 series	NA	100 sf/gal	16 WFT/12 DFT	16 hours

Seed and Backroll Method

1. Primer: Thoroughly mix and apply selected primer and apply at a rate of 300 sf/gal (0.33 gal/100 sf) and allow to cure. 7797/7798 may be applied at up to 500 sf/gal (0.2 gal/100 sf).
2. Base Coat: Thoroughly mix and apply 70410 at 60 sf/gal (1.66 gal/100 sf or 26 wet mils) to yield 20 dry mils and allow to cure. The Base Coat must be applied within 24 hours of priming, otherwise clean deck and re-prime as outlined above.
3. Heavy Duty Areas (turns, ramps, ticket spitters, etc.): Note: For parking stalls and non-heavy duty service, skip this step and proceed to the next item. Thoroughly mix and apply Wear Coat of 7430 series at 100 sf/gal (1.0 gal/100 sf or 16 wet mils) to yield 12 dry mils and immediately broadcast 7992 aggregate, evenly distributed, into wet coating at a rate of 10 lbs/100 sf and allow to cure. Remove loose aggregate by blowing, sweeping or vacuuming.

(continued on next page)

4. Topcoat: Thoroughly mix and apply 7470 series at 60 sf/gal (1.66 gal/100 sf or 26 wet mils) to yield 20 dry mils and immediately broadcast aggregate, evenly distributed, into wet coating at a rate of approximately 15 lbs/100 sf and backroll to encapsulate aggregate. Allow to cure.
5. Do not allow traffic on coated surfaces for at least 72 hours at 75°F/23°C.

Summary Application Table

Coat	Product	Mix Ratio	Coverage Rate	Mils WFT/DFT	Recoat Time at 75°F/23°C
Primer	7760/7761	1:1	300 sf/gal	NA	1.5–2 hours
	7780/7781	4:1	300 sf/gal		1.5–2 hours
	7797/7798	2:1	300–500 sf/gal		5–6 hours
Base Coat	70410	NA	60 sf/gal	26 WFT/20 DFT	14 hours
HD Wear Coat Aggregate	7430 series 7992	NA	100 sf/gal 10 lbs/100 sf	16 WFT/12 DFT	12 hours
Topcoat Aggregate	7470 7992	NA	60 sf/gal 15 lbs/100 sf	26 WFT/20 DFT	12 hours

Auto-Gard Aliphatic T

Materials

- Primers: 7760/7761 (25100), 7780/7781 (280JB), or 7797/7798 (254JB).
- Flashing Tape: 86218 (62ZJB) flashing tape.
- Base Coat: 70410 (45010) or 7430 (57040) urethane.
- Topcoat: 7475 (47MJB) series integrally textured aliphatic urethane.

Note: For lower odor, use 7780/7781 or 7797/7798 primer.

Dry Film Thickness

- Standard system: 40 dry mils (excluding primer).
- Heavy duty in high wear areas (turns, ramps, ticket spitters, etc.): 52 dry mils (excluding primer and aggregate).

Application Instructions

1. Primer: Thoroughly mix and apply selected primer and apply at a rate of 300 sf/gal (0.33 gal/100 sf) and allow to cure. 7797/7798 may be applied at up to 500 sf/gal (0.2 gal/100 sf).
2. Base Coat: Thoroughly mix 70410 or 7430 and apply at a rate of 60 sf/gal (1.66 gal/100 sf or 26 wet mils), to yield 20 dry mils. Extend base coat over cracks and control joints which have received detail treatment.

Note: Do not dip and roll 7475 material from container.

3. Double Texture: For heavy duty traffic areas such as ticket booths, spiral ramps, turn areas, or in other areas subjected to extremely high traffic abrasion, apply double texture. In such areas, thoroughly mix 7475 and apply at a rate of 90–100 sf/gal (1.1–1.0 gal/100 sf). Use a 1/8" notched squeegee and 3/8"-1/2" nap roller cover to uniformly backroll prior to applying topcoat.
4. Topcoat: Thoroughly mix 7475 series and apply 1/8" notched squeegee, at the rate of 62 sf/gal (1.66 gal/100 sf or 26 wet mils) to yield 20 dry mils. Topcoat should be back rolled two times, one perpendicular to the other.

Summary Application Table

Coat	Product	Mix Ratio	Coverage Rate	Mils WFT/DFT	Recoat Time at 75° F/23° C
Primer	7760/7761	1:1	300 sf/gal	NA	1.5–2 hours
	7780/7781	4:1	300 sf/gal		1.5–2 hours
	7797/7798	2:1	300–500 sf/gal		5–6 hours
Base Coat	70410 or 7430	NA	60 sf/gal	26 WFT/20 DFT	14 hours
Double Texture	7475	NA	90–100 sf/gal	16 WFT/12 DFT	12 hours
Topcoat	7475	NA	62 sf/gal	26 WFT/20 DFT	12 hours

Auto-Gard FC

Materials

- Primers: 7780/7781 (280JB) or 7797/7798 (254JB).
- Aggregate: 7992-U (66EJB) 12/20 mesh silica quartz sand.
- Base Coat: FC7500/FC7960 (45063) urethane.
- Wear Coat: FC7510/FC7961 (47PJB) urethane.
- Topcoat (choose one):
 - Non-UV Exposed Applications: FC7510/FC7961 (47PJB) urethane.
 - UV Exposed Applications: FC7540/FC7964 (47QJB) series urethane.

Dry Film Thickness

- Standard system: 40 dry mils (excluding primer and aggregate).
- Heavy duty in high wear areas (turns, ramps, ticket spitters, etc.): 52 dry mils (excluding primer and aggregate).

Application Instructions

Seed and Lock Method

1. Primer: Thoroughly mix and apply selected primer and apply at a rate of 300 sf/gal (0.33 gal/100 sf) and allow to cure. 7797/7798 may be applied at up to 500 sf/gal (0.2 gal/100 sf).
2. Base Coat: Thoroughly mix and apply FC7500/FC7960 at 80 sf/gal (1.25 gal/100 sf or 20 wet mils) to yield 20 dry mils and allow to cure. The Base Coat must be applied within 24 hours of priming, otherwise clean deck and re-prime as outlined above. Note: Do not leave base coat exposed for more than 5 days.
3. Wear Coat: Thoroughly mix and apply FC7510/FC7961 at 200 sf/gal (0.5 gal/100 sf or 8 wet mils) to yield 8 dry mils. While the Wear Coat is still wet, broadcast 7992-U aggregate at the rate of 15 lbs/100 sf into the system and allow to cure. Remove loose aggregate by blowing, sweeping or vacuuming.
4. Heavy Duty Areas (turns, ramps, ticket spitters, etc.): Note: For parking stalls and non-heavy duty service, skip this step and proceed to the next item. Thoroughly mix and apply a second Wear Coat of FC7510/FC7961 at 133 sf/gal (0.75 gal/100 sf or 12 wet mils) to yield 12 dry mils.
5. Immediately broadcast 7992-U aggregate, evenly distributed, into wet coating at the rate of 10 lbs/100 sf into the system and allow to cure. Remove loose aggregate by blowing, sweeping or vacuuming.

(continued on next page)

6. Topcoat:

- A. Non-UV Exposure: Thoroughly mix and apply FC7510/FC7961 at 133 sf/gal (0.75 gal/100 sf or 12 wet mils) to yield 12 dry mils
- B. UV Exposure: Thoroughly mix and apply FC7540/FC7964 at 120 sf/gal (0.83 gal/100 sf or 13 wet mils) to yield 12 dry mils. Allow to cure.

7. Do not allow traffic on coated surfaces for at least 24–36 hours at 75°F/23°C, 50% relative humidity.

Summary Application Table

Coat	Product	Mix Ratio	Coverage Rate	Mils WFT/DFT	Recoat Time at 75°F/23°C
Primer	7780/7781	4:1	300 sf/gal	NA	1.5–2 hours
	7797/7798	2:1	300–500 sf/gal		5–6 hours
Base Coat	FC7500/FC7960	9:1	80 sf/gal	20 WFT/20 DFT	3–4 hours
Wear Coat Aggregate	FC7510/FC7961 7992-U	3:1	200 sf/gal 15 lbs/100 sf	8 WFT/8 DFT	5–6 hours
HD Wear Coat Aggregate	FC7510/FC7961 7992-U	3:1	133 sf/gal 10 lbs/100 sf	12 WFT/12 DFT	5–6 hours
Topcoat: Non-UV UV	FC7510/FC7961	3:1	133 sf/gal	12 WFT/12 DFT	5–6 hours
	FC7540/FC7964	2:1	120 sf/gal	13 WFT/12 DFT	3–4 hours

Seed and Backroll Method

1. Primer: Thoroughly mix and apply selected primer and apply at a rate of 300 sf/gal (0.33 gal/100 sf) and allow to cure. 7797/7798 may be applied at up to 500 sf/gal (0.2 gal/100 sf).
2. Base Coat: Thoroughly mix and apply FC7500/FC7960 at 80 sf/gal (1.25 gal/100 sf or 20 wet mils) to yield 20 dry mils and allow to cure. The Base Coat must be applied within 24 hours of priming, otherwise clean deck and re-prime as outlined above. Note: Do not leave base coat exposed for more than 5 days.
3. Heavy Duty Areas (turns, ramps, ticket spitters, etc.): Note: For parking stalls and non-heavy duty service, skip this step and proceed to the next item. Thoroughly and apply FC7510/FC7961 at 133 sf/gal (0.75 gal/100 sf or 12 wet mils) to yield 12 dry mils and immediately broadcast 7992-U aggregate, evenly distributed, into wet coating at a rate of 10 lbs/100 sf and allow to cure. Remove loose aggregate by blowing, sweeping or vacuuming.
4. Topcoat:
 - A. Non-UV Exposure: Thoroughly mix and apply FC7510/FC7961 at 133 sf/gal (0.75 gal/100 sf or 12 wet mils) to yield 12 dry mils
 - B. UV Exposure: Thoroughly mix and apply FC7540/FC7964 at 120 sf/gal (0.83 gal/100 sf or 13 wet mils) to yield 12 dry mils. Allow to cure.
5. Do not allow traffic on coated surfaces for at least 24-36 hours at 75°F/23°C.

Summary Application Table

Coat	Product	Mix Ratio	Coverage Rate	Mils WFT/DFT	Recoat Time at 75°F/23°C
Primer	7780/7781	4:1	300 sf/gal	NA	1.5–2 hours
	7797/7798	2:1	300–500 sf/gal		5–6 hours
Base Coat	FC7500/FC7960	9:1	80 sf/gal	20 WFT/20 DFT	3–4 hours

Coat	Product	Mix Ratio	Coverage Rate	Mils WFT/DFT	Recoat Time at 75°F/23°C
HD Wear Coat Aggregate	FC7510/FC7961 7992-U	3:1	133 sf/gal 10 lbs/100 sf	12 WFT/12 DFT	5–6 hours
Topcoat: Non-UV Topcoat: UV Aggregate	FC7510/FC7961 FC7540/FC7964 7992-U	3:1 2:1	80 sf/gal 70 sf/gal 15 lbs/100 sf	20 WFT/20 DFT 22 WFT/20 DFT	5–6 hours 3–4 hours

Auto-Gard FC Aliphatic

Materials

- Primers: 7780/7781 (280JB) or 7797/7798 (254JB).
- Aggregate: 7992 (66010) silica quartz sand.
- Base Coat: FC7500/FC7960 (45063) urethane.
- Wear Coat: FC7530/FC7963 (57060) aliphatic urethane.
- Topcoat: FC7530/FC7963 (57060) aliphatic urethane.

Dry Film Thickness

- Standard system: 40 dry mils (excluding primer and aggregate).
- Heavy duty in high wear areas (turns, ramps, ticket spitters, etc.): 52 dry mils (excluding primer and aggregate).

Application Instructions

1. Primer: Thoroughly mix and apply selected primer and apply at a rate of 300 sf/gal (0.33 gal/100 sf) and allow to cure. 7797/7798 may be applied at up to 500 sf/gal (0.2 gal/100 sf).
2. Base Coat: Thoroughly mix and apply FC7500/FC7960 at 80 sf/gal (1.25 gal/100 sf or 20 wet mils) to yield 20 dry mils and allow to cure. The Base Coat must be applied within 24 hours of priming, otherwise clean deck and re-prime as outlined above. Note: Do not leave base coat exposed for more than 5 days.
3. Wear Coat: Thoroughly mix and apply FC7530/FC7963 at 200 sf/gal (0.5 gal/100 sf or 8 wet mils) to yield 8 dry mils and immediately broadcast 7992-U aggregate, evenly distributed, into wet coating at the rate of 15 lbs/100 sf into the system and allow to cure. Remove loose aggregate by blowing, sweeping or vacuuming.
4. Heavy Duty Areas (turns, ramps, ticket spitters, etc.): Note: For parking stalls and non-heavy duty service, skip this step and proceed to the next item. Thoroughly mix and apply a second Wear Coat of FC7530/FC7963 at 133 sf/gal (0.75 gal/100 sf or 12 wet mils) to yield 12 dry mils. Immediately broadcast 7992-U aggregate, evenly distributed, into wet coating at the rate of 10 lbs/100 sf and allow to cure. Remove loose aggregate by blowing, sweeping or vacuuming.
5. Topcoat: Thoroughly mix and apply FC7530/FC7963 at 133 sf/gal (0.75 gal/100 sf or 12 wet mils) to yield 12 dry mils. Allow to cure.
6. Do not allow traffic on coated surfaces for at least 24-36 hours at 75°F/23°C, 50% relative humidity.

(continued on next page)

Summary Application Table

Coat	Product	Mix Ratio	Coverage Rate	Mils WFT/DFT	Recoat Time at 75°F/23°C
Primer	7780/7781	4:1	300 sf/gal	NA	1.5–2 hours 5–6 hours
	7797/7798	2:1	300–500 sf/gal		
Base Coat	FC7500/FC7960	9:1	80 sf/gal	20 WFT/20 DFT	3–4 hours
Wear Coat Aggregate	FC7510/FC7961	3:1	200 sf/gal	8 WFT/8 DFT	5–6 hours
	7992-U		15 lbs/100 sf		
or					
HD Wear Coat Aggregate	FC7530/FC7963	85:15	133 sf/gal 10 lbs/100 sf	12 WFT/12 DFT	5–6 hours
Topcoat	FC7530/FC7963	85:15	133 sf/gal	12 WFT/12 DFT	5–6 hours

Auto-Gard FC T

Materials

- Primers: 7780/7781 (280JB) or 7797/7798 (254JB).
- Base Coat: FC7500/FC7960 (45063) urethane.
- Heavy Duty Wear Coat: FC7545/FC7964 (47QJB) integrally textured urethane.
- Topcoat: FC7545/FC7964 (47RJB) integrally textured urethane.

Dry Film Thickness

- Standard system: 40 dry mils (excluding primer and aggregate).
- Heavy duty in high wear areas (turns, ramps, ticket spitters, etc.): 52 dry mils (excluding primer and aggregate).

Application Instructions

1. Primer: Thoroughly mix and apply selected primer and apply at a rate of 300 sf/gal (0.33 gal/100 sf) and allow to cure. 7797/7798 may be applied at up to 500 sf/gal (0.2 gal/100 sf).
2. Base Coat: Thoroughly mix and apply FC7500/FC7960 at 80 sf/gal (1.25 gal/100 sf or 20 wet mils) to yield 20 dry mils and allow to cure. The Base Coat must be applied within 24 hours of priming, otherwise clean deck and re-prime as outlined above. Note: Do not leave base coat exposed for more than 5 days.

Note: Do not dip and roll FC7545/FC7964 material from container.

3. Double Texture: For heavy duty traffic areas such as ticket booths, spiral ramps, turn areas, or in other areas subjected to extremely high traffic abrasion, heavy duty application is required. In such areas, thoroughly mix FC7545/FC7964 and apply at a rate of 90–133 sf/gal (1.1– gal/100 sf or approximately 13 wet mils) to yield approximately 12 dry mils using a 1/8" notched squeegee and 3/8"–1/2" nap roller cover to uniformly backroll prior to applying topcoat.
4. Topcoat: Thoroughly mix and apply FC7545/7964 at 70 sf/gal (1.43 gal/100 sf or 23 wet mils) to yield 20 dry mils using a 1/8" notched squeegee and 3/8"–1/2" nap roller cover. Topcoat should be applied uniformly and backrolled two times, with coats perpendicular to one other.
5. Do not allow traffic on coated surfaces for at least 24–36 hours at 75°F/23°C, 50% relative humidity.

Summary Application Table

Coat	Product	Mix Ratio	Coverage Rate	Mils WFT/DFT	Recoat Time at 75° F/23° C
Primer	7780/7781	4:1	300 sf/gal	NA	1.5–2 hours
	7797/7798	2:1	300–500 sf/gal		5–6 hours
Base Coat	FC7500/FC7960	9:1	80 sf/gal	20 WFT/20 DFT	3–4 hours
Double Texture	FC7545/FC7964	2:1	90–133 sf/gal	13 WFT/12 DFT	3–4 hours
Topcoat	FC7545/FC7964	2:1	70 sf/gal	23 WFT/20 DFT	3–4 hours

Auto-Gard E

Materials

- Primers: 7780/7781 (280JB) or 7797/7798 (254JB).
- Aggregate: 7992-U (66EJB) silica quartz sand or #16 aluminum oxide.
- Base Coat: FC7500/FC7960 (45063) urethane.
- Wear Coat: 70750/70751 (472JB) low-modulus epoxy.
- Topcoat (choose one):
 - Epoxy: 70714/70715-09 (45062) pigmented 100% solids epoxy.
 - Urethane: FC7540/FC7964 (47QJB) aliphatic urethane.

Note: If system is required to be low odor, use 7780/7781 or 7797/7798 primer.

Average Dry Film Thickness

- Standard system: 46 dry mils (excluding primer and aggregate).
- Heavy duty in high wear areas (turns, ramps, ticket spitters, etc.): 50 dry mils (excluding primer and aggregate).

Application Instructions

1. Primer: Thoroughly mix and apply selected primer and apply at a rate of 300 sf/gal (0.33 gal/100 sf) and allow to cure. 7797/7798 may be applied at up to 500 sf/gal (0.2 gal/100 sf).
2. Base Coat: Thoroughly mix and apply FC7500/FC7960 at 80 sf/gal (1.25 gal/100 sf or 20 wet mils) to yield 20 dry mils and allow to cure. The Base Coat must be applied within 24 hours of priming, otherwise clean deck and re-prime as outlined above. Note: Do not leave base coat exposed for more than 5 days.
3. Wear Coat: Note: The system is designed for one wear coat application.
 - A. Standard Duty: Thoroughly mix 70750/70751 and apply at a rate of 133 sf/gal (0.75 gal/100 sf or 12 wet mils) to yield 12 dry mils, and immediately broadcast selected aggregate, evenly distributed, into wet epoxy at the rate of 15 lbs per 100 square feet. When dry, remove excess aggregate.
 - B. Heavy Duty: Thoroughly mix 70750/70751 and apply at a rate of 100 sf/gal (1.0 gal/100 sf or 16 wet mils) to yield 16 dry mils, and immediately broadcast selected aggregate, evenly distributed, into wet coating at the rate of 15 lbs per 100 square feet. When dry, remove excess aggregate.

(continued on next page)

4. Topcoat:

- A. Non-UV Exposure: Thoroughly mix and apply 70714/70715-09 (for non-UV exposure) at 110 sf/gal (0.90 gal/100 sf or 14 wet mils).
- B. UV Exposure: Thoroughly mix and apply FC7540/FC7964 (for UV exposure) two-component polyurethane mix at 100 sf/gal (1.0 gal/100 sf or 16 wet mils) to yield 14 dry mils. Allow to cure.

5. Do not allow traffic on coated surfaces for at least 24-36 hours at 75°F/23°C, 50% relative humidity.

Summary Application Table

Coat	Product	Mix Ratio	Coverage Rate	Mils WFT/DFT	Recoat Time at 75°F/23°C
Primer	7780/7781	4:1	300 sf/gal	NA	1.5–2 hours
	7797/7798	2:1	300–500 sf/gal		5–6 hours
Base Coat	FC7500/FC7960	9:1	80 sf/gal	20 WFT/20 DFT	3–4 hours
Wear Coat Aggregate	70750/70751 7992-U	2:1	133 sf/gal 15 lbs/100 sf	12 WFT/12 DFT	8–9 hours
or HD Wear Coat Aggregate	70714/70715-09 Clear 7992-U	2:1	100 sf/gal 15 lbs/100 sf	16 WFT/16 DFT	8–9 hours
Topcoat: Non-UV UV	70714/70715-09 Pigmented FC7540/FC7964	2:1	110 sf/gal	14 WFT/14 DFT	8–9 hours
		2:1	100 sf/gal	16 WFT/14 DFT	3–4 hours

Auto-Gard F

Materials

- Primers: 7760/7761 (25100), 7780/7781 (280JB), or 7797/7798 (254JB).
- Aggregate: Uniformly graded #3 flint.
- Base Coat: FC7500/FC7960 (45063) urethane.
- Wear Coat: 70714/70715-09 (45062) 100% solids epoxy.
- Topcoat:
 - Non-UV Exposed Applications: 70714/70715-09 (45062) 100% solids pigmented epoxy.
 - UV Exposed Applications: FC7540/FC7964 (47QJB) series urethane.

Note: For lower odor, use 7780/7781 or 7797/7798 primer.

Average Dry Film Thickness

- 56 dry mils (excluding primer and aggregate).

Application Instructions

1. Primer: Thoroughly mix and apply selected primer and apply at a rate of 300 sf/gal (0.33 gal/100 sf) and allow to cure. 7797/7798 may be applied at up to 500 sf/gal (0.2 gal/100 sf).
2. Base Coat: Thoroughly mix and apply FC7500/FC7960 at 80 sf/gal (1.25 gal/100 sf or 20 wet mils) to yield 20 dry mils and allow to cure. The Base Coat must be applied within 24 hours of priming, otherwise clean deck and re-prime as outlined above. Note: Do not leave base coat exposed for more than 5 days.

- Wear Coat: Thoroughly mix and apply 70714/70715-09 at 133 sf/gal (0.75 gal/100 sf or 12 wet mils) to yield 12 dry mils and immediately broadcast 84059 #3 flint into wet coating to point of rejection (30 lbs/100 sf), and allow to cure. Remove loose aggregate by blowing, sweeping or vacuuming.
- Topcoat: Thoroughly mix and apply 70714/70715-09 at 66 sf/gal (1.5 gal/100 sf or 24 wet mils) or FC7540/FC7964 two-component polyurethane (for UV exposure) at 60 sf/gal (1.66 gal/100 sf or 26 wet mils) to yield 24 dry mils and allow to cure.
- Do not allow traffic on coated surfaces for at least 24-36 hours at 75°F/23°C, 50% relative humidity.

Summary Application Table

Coat	Product	Mix Ratio	Coverage Rate	Mils WFT/DFT	Recoat Time at 75°F/23°C
Primer	7760/7761	1:1	300 sf/gal	NA	1.5–2 hours
	7780/7781	4:1	300 sf/gal		1.5–2 hours
	7797/7798	2:1	300–500 sf/gal		5–6 hours
Base Coat	FC7500/FC7960	9:1	80 sf/gal	20 WFT/20 DFT	3–4 hours
Wear Coat Aggregate	70714/70715-09 Epoxy #3 Flint	2:1	133 sf/gal 30 lbs/100 sf	12 WFT/12 DFT	8–9 hours
Topcoat: Non-UV UV	70714/70715-09 Pigmented Epoxy FC7540/FC7964	2:1	66 sf/gal	24 WFT/24 DFT	8–9 hours
		2:1	60 sf/gal	26 WFT/24 DFT	3–4 hours

Peda-Gard

Materials

- Primers: 7760/7761 (25100), 7780/7781 (280JB), or 7797/7798 (254JB).
- Aggregate: 7992 (66010) 16/30 mesh silica quartz sand.
- Base Coat: 70410 (45010) urethane.
- Wear Coat: 7430 (57040) series urethane.
- Topcoat: 7430 (57040) series urethane.

Note: For lower odor, use 7780/7781 or 7797/7798 primer.

Average Dry Film Thickness

- 32 dry mils (excluding primer and aggregate).

Application Instructions

Seed and Lock Method

- Primer: Thoroughly mix and apply selected primer and apply at a rate of 300 sf/gal (0.33 gal/100 sf) and allow to cure. 7797/7798 may be applied at up to 500 sf/gal (0.2 gal/100 sf).
- Base Coat: Thoroughly mix and apply 70410 polyurethane at 66 sf/gal (1.5 gal/100 sf or 24 wet mils) to yield 18 dry mils and allow to cure. The Base Coat must be applied within 24 hours of priming, otherwise clean deck and re-prime as outlined above. Note: Do not leave base coat exposed for more than 5 days.
- Wear Coat: Thoroughly mix and apply 7430 series at 200 sf/gal (0.5 gal/100 sf or 8 wet mils) to yield 6 dry mils and immediately broadcast 7992 aggregate, evenly distributed, into wet coating at a rate of 10 lbs/100 square feet and allow to cure. Remove loose aggregate by blowing, sweeping or vacuuming.

4. Topcoat: Thoroughly mix and apply 7430 series at 150 sf/gal (0.66 gal/100 sf or 10 wet mils) to yield 8 dry mils and allow to cure.
5. Do not allow traffic on coated surfaces for at least 48 hours at 75°F/23°C, 50% relative humidity.

Summary Application Table

Coat	Product	Mix Ratio	Coverage Rate	Mils WFT/DFT	Recoat Time at 75°F/23°C
Primer	7760/7761	1:1	300 sf/gal	NA	1.5–2 hours
	7780/7781	4:1	300 sf/gal		1.5–2 hours
	7797/7798	2:1	300–500 sf/gal		5–6 hours
Base Coat	70410	NA	66 sf/gal	24 WFT/18 DFT	14 hours
Wear Coat Aggregate	7430 series 7992	NA	200 sf/gal 10 lbs/100 sf	8 WFT/6 DFT	12 hours
Topcoat	7430 series	NA	150 sf/gal	10 WFT/8 DFT	12 hours

Seed and Backroll Method

1. Primer: Thoroughly mix and apply selected primer and apply at a rate of 300 sf/gal (0.33 gal/100 sf) and allow to cure. 7797/7798 may be applied at up to 500 sf/gal (0.2 gal/100 sf).
2. Base Coat: Thoroughly mix and apply 70410 polyurethane at 60 sf/gal (1.66 gal/100 sf or 26 wet mils) to yield 20 dry mils and allow to cure. The Base Coat must be applied within 24 hours of priming, otherwise clean deck and re-prime as outlined above.
3. Topcoat: Thoroughly mix and apply 7430 series at 100 sf/gal (1.0 gal/100 sf or 16 wet mils) to yield 12 dry mils and immediately broadcast 7992 aggregate, evenly distributed, into wet coating at a rate of approximately 10 lbs/100 sf and backroll to encapsulate aggregate.
4. Do not allow traffic on coated surfaces for at least 48 hours at 75°F/23°C, 50% relative humidity.

Summary Application Table

Coat	Product	Mix Ratio	Coverage Rate	Mils WFT/DFT	Recoat Time at 75°F/23°C
Primer	7760/7761	1:1	300 sf/gal	NA	1.5–2 hours
	7780/7781	4:1	300 sf/gal		1.5–2 hours
	7797/7798	2:1	300–500 sf/gal		5–6 hours
Base Coat	70410	NA	60 sf/gal	26 WFT/20 DFT	14 hours
Topcoat Aggregate	7430 series 7992	NA	100 sf/gal 10 lbs/100 sf	16 WFT/12 DFT	12 hours

Peda-Gard Aliphatic

Materials

- Primers: 7760/7761 (25100), 7780/7781 (280JB), or 7797/7798 (254JB).
- Aggregate: 7992 (66010) 16/30 mesh silica quartz sand.
- Base Coat: 70410 (45010) urethane.
- Wear Coat: 7430 (57040) series urethane.
- Topcoat: 7470 (47LJB) series aliphatic urethane.

Note: For lower odor, use 7780/7781 or 7797/7798 primer.

Average Dry Film Thickness

- 32 dry mils (excluding primer and aggregate).

Application Instructions

Seed and Lock Method

1. Primer: Thoroughly mix and apply selected primer and apply at a rate of 300 sf/gal (0.33 gal/100 sf) and allow to cure. 7797/7798 may be applied at up to 500 sf/gal (0.2 gal/100 sf).
2. Base Coat: Thoroughly mix 70410 and apply at a rate of 66 sf/gal (1.5 gal/100 sf or 24 wet mils), to yield 18 dry mils. Extend base coat over cracks and control joints which have received detail treatment.
3. Wear Coat: Thoroughly mix 7430 series and apply at a rate of 200 sf/gal (0.5 gal/100 sf or 8 wet mils) to yield 6 dry mils, and immediately broadcast aggregate, evenly distributed, into wet coating at the rate of 10 lbs/100 sf. When dry, remove excess aggregate.
4. Topcoat: Thoroughly mix 7470 series and apply at a rate of 150 sf/gal (0.66 gal/100 sf or 10 wet mils) to yield 8 dry mils.
5. Do not allow traffic on coated surfaces for at least 48 hours at 75°F/23°C, 50% relative humidity.

Summary Application Table

Coat	Product	Mix Ratio	Coverage Rate	Mils WFT/DFT	Recoat Time at 75°F/23°C
Primer	7760/7761	1:1	300 sf/gal	NA	1.5–2 hours
	7780/7781	4:1	300 sf/gal		1.5–2 hours
	7797/7798	2:1	300–500 sf/gal		5–6 hours
Base Coat	70410	NA	66 sf/gal	24 WFT/18 DFT	14 hours
Wear Coat Aggregate	7430 series 7992	NA	200 sf/gal 10 lbs/100 sf	8 WFT/6 DFT	12 hours
Topcoat	7470 series	NA	150 sf/gal	10 WFT/8 DFT	16 hours

Seed and Backroll Method

1. Primer: Thoroughly mix and apply selected primer and apply at a rate of 300 sf/gal (0.33 gal/100 sf) and allow to cure. 7797/7798 may be applied at up to 500 sf/gal (0.2 gal/100 sf).
2. Base Coat: Thoroughly mix 70410 and apply at a rate of 60 sf/gal (1.66 gal/100 sf or 26 wet mils), to yield 20 dry mils. Extend base coat over cracks and control joints which have received detail treatment.
3. Topcoat: Thoroughly mix 7470 and apply at a rate of 100 sf/gal (1.0 gal/100 sf or 16 wet mils) to yield 12 dry mils. Immediately broadcast aggregate at a rate of approximately 10 lbs/100 sf and backroll to encapsulate aggregate.
4. Do not allow traffic on coated surfaces for at least 48 hours at 75°F/23°C, 50% relative humidity.

(continued on next page)

Summary Application Table

Coat	Product	Mix Ratio	Coverage Rate	Mils WFT/DFT	Recoat Time at 75 °F/23 °C
Primer	7760/7761	1:1	300 sf/gal	NA	1.5–2 hours
	7780/7781	4:1	300 sf/gal		1.5–2 hours
	7797/7798	2:1	300–500 sf/gal		5–6 hours
Base Coat	70410	NA	60 sf/gal	26 WFT/20 DFT	14 hours
Topcoat Aggregate	7470 series 7992	NA	100 sf/gal 10 lbs/100 sf	16 WFT/12 DFT	16 hours

Peda-Gard Aliphatic T

Materials

- Primers: 7760/7761 (25100) or 7780/7781 (280JB).
- Base Coat: 70410 (45010) or 7430 series (57040) urethane.
- Topcoat: 7478 series (47BJB) aliphatic urethane.

Note: For lower odor, use 7780/7781 primer.

Note: Accelerators may be blended with 70410 and 7430 series polyurethanes to speed curing. See “Additives” and “Curing Charts” in the Support Information section of this Application Manual.

Average Dry Film Thickness

- 32 dry mils (excluding primer).

Application Instructions

1. Primer: Thoroughly mix and apply selected primer and apply at a rate of 300 sf/gal (0.33 gal/100 sf) and allow to cure. 7797/7798 may be applied at up to 500 sf/gal (0.2 gal/100 sf).
2. Base Coat: Thoroughly mix 70410 or 7430 and apply at a rate of 60 sf/gal (1.66 gal/100 sf or 26 wet mils), to yield 20 dry mils. Extend base coat over cracks and control joints which have received detail treatment.

Note: Do not dip and roll 7478 material from container.

3. Topcoat: After base coat is dry, thoroughly mix 7478 series and apply with a 1/16” notched squeegee at a rate of 104 sf/gal (.96 gal/100 sf or 16 wet mils) to yield 12 dry mils. Topcoat should be backrolled two times, one pass perpendicular to the other.

Summary Application Table

Coat	Product	Mix Ratio	Coverage Rate	Mils WFT/DFT	Recoat Time at 75 °F/23 °C
Primer	7760/7761	1:1	300 sf/gal	NA	1.5–2 hours
	7780/7781	4:1	300 sf/gal		1.5–2 hours
	7797/7798	2:1	300–500 sf/gal		5–6 hours
Base Coat	70410 or 7430	NA	60 sf/gal	26 WFT/20 DFT	14 hours
Topcoat	7478 series	NA	75 sf/gal	16 WFT/12 DFT	NA

Peda-Gard FC

Materials

- Primers: 7780/7781 (280JB) or 7797/7798 (254JB).
- Aggregate: 7992 (66010) 16/30 mesh silica quartz sand.
- Base Coat: FC7500/FC7960 (45063) urethane.
- Wear Coat: FC7510/FC7961 (47PJB) urethane.
- Topcoat (choose one):
 - Non-UV Exposed Applications: FC7510/FC7961 (47PJB) urethane.
 - UV Exposed Applications: FC7540/FC7964 (47QJB) series urethane.

Average Dry Film Thickness

- 35 dry mils (excluding primer and aggregate).

Application Instructions

Seed and Lock Method

1. Primer: Thoroughly mix and apply selected primer and apply at a rate of 300 sf/gal (0.33 gal/100 sf) and allow to cure. 7797/7798 may be applied at up to 500 sf/gal (0.2 gal/100 sf).
2. Base Coat: Thoroughly mix and apply FC7500/FC7960 at 88 sf/gal (1.13 gal/100 sf or 18 wet mils) to yield 18 dry mils and allow to cure. The Base Coat must be applied within 24 hours of priming, otherwise clean deck and re-prime as outlined above. Note: Do not leave base coat exposed for more than 5 days.
3. Wear Coat: Thoroughly mix and apply FC7510/FC7961 at 200 sf/gal (0.5 gal/100 sf or 8 wet mils) to yield 8 dry mils and immediately broadcast 7992 aggregate, evenly distributed, into wet coating at the rate of 10 lbs/100 sf and allow to cure. Remove loose aggregate by blowing, sweeping or vacuuming.
4. Topcoat:
 - A. Non-UV Exposure: Thoroughly mix and apply FC7510/FC7961 at 175 sf/gal (0.57 gal/100 sf or 9 wet mils) to yeild 9 dry mils and allow to cure.
 - B. UV Exposure: Thoroughly mix and apply FC7540/FC7964 (for UV exposure) at 160 sf/gal (0.62 gal/100 sf or 10 wet mils) to yield 9 dry mils and allow to cure.
5. Do not allow traffic on coated surfaces for at least 48 hours at 75°F/23°C, 50% relative humidity.

Summary Application Table

Coat	Product	Mix Ratio	Coverage Rate	Mils WFT/DFT	Recoat Time at 75°F/23°C
Primer	7780/7781	4:1	300 sf/gal	NA	1.5–2 hours
	7797/7798	2:1	300–500 sf/gal		5–6 hours
Base Coat	FC7500/FC7960	9:1	88 sf/gal	18 WFT/18 DFT	3–4 hours
Wear Coat Aggregate	FC7510/FC7961 7992	3:1	200 sf/gal 10 lbs/100 sf	8 WFT/8 DFT	5–6 hours
Topcoat: Non UV UV	FC7510/FC7961	3:1	175 sf/gal	9 WFT/9 DFT	5–6 hours
	FC7540/FC7964	2:1	160 sf/gal	10 WFT/9 DFT	3–4 hours

(continued on next page)

Seed and Backroll Method

- Primer: Thoroughly mix and apply selected primer and apply at a rate of 300 sf/gal (0.33 gal/100 sf) and allow to cure. 7797/7798 may be applied at up to 500 sf/gal (0.2 gal/100 sf).
- Base Coat: Thoroughly mix and apply FC7500/FC7960 at 80 sf/gal (1.25 gal/100 sf or 20 wet mils) to yield 20 dry mils and allow to cure. The Base Coat must be applied within 24 hours of priming, otherwise clean deck and re-prime as outlined above. Note: Do not leave base coat exposed for more than 5 days.
- Topcoat:
 - Non-UV Exposure: Thoroughly mix and apply FC7510/FC7961 at 106 sf/gal (0.93 gal/100 sf or 15 wet mils) and immediately broadcast 7992 aggregate, evenly distributed, into wet coating at a rate of approximately 10 lbs/100 sf and backroll to encapsulate aggregate. Allow to cure.
 - UV Exposure: FC7540/FC7964 series at 95 sf/gal (1.05 gal/100 sf or 16 wet mils) to yield 15 dry mils and immediately broadcast 7992 aggregate, evenly distributed, into wet coating at a rate of approximately 10 lbs/100 sf and backroll to encapsulate aggregate. Allow to cure.
- Do not allow traffic on coated surfaces for at least 48 hours at 75°F/23°C, 50% relative humidity.

Summary Application Table

Coat	Product	Mix Ratio	Coverage Rate	Mils WFT/DFT	Recoat Time at 75°F/23°C
Primer	7780/7781 7797/7798	4:1 2:1	300 sf/gal 300–500 sf/gal	NA	1.5–2 hours
Base Coat	FC7500/FC7960	9:1	80 sf/gal	20 WFT/20 DFT	3–4 hours
Topcoat: Non-UV	FC7510/FC7961	3:1	106 sf/gal	15 WFT/15 DFT	5–6 hours
Topcoat: UV	FC7540/FC7964	2:1	95 sf/gal	16 WFT/15 DFT	3–4 hours
Aggregate	7992		10 lbs/100 sq ft		

Peda-Gard FC T

Materials

- Primers: 7780/7781 (280JB) or 7797/7798 (254JB).
- Base Coat: FC7500/FC7960 (45063) urethane.
- Topcoat: FC7548/FC7964 (47TJ9/ 949JB) urethane.

Average Dry Film Thickness

- 32 dry mils (excluding primer).

Application Instructions

- Primer: Thoroughly mix and apply selected primer and apply at a rate of 300 sf/gal (0.33 gal/100 sf) and allow to cure. 7797/7798 may be applied at up to 500 sf/gal (0.2 gal/100 sf).
- Base Coat: Thoroughly mix FC7500/FC7960 and apply at a rate of 80 sf/gal (1.25 gal/100 sf or 20 wet mils), to yield 20 dry mils. Extend base coat over cracks and control joints which have received detail treatment.

Note: Do not dip and roll FC7548/FC7964 material from container.

- Topcoat: Thoroughly mix FC7548/FC7964 series and apply with a 1/16" notched squeegee at a rate of

120 sf/gal (0.83 gal/100 sf or 13 wet mils) to yield 12 dry mils. Topcoat should be backrolled two times, one perpendicular to the other.

- Do not allow traffic on coated surfaces for at least 24 hours at 75°F/23°C, 50% relative humidity.

Summary Application Table

Coat	Product	Mix Ratio	Coverage Rate	Mils WFT/DFT	Recoat Time at 75°F/23°C
Primer	7780/7781	4:1	300 sf/gal	NA	1.5–2 hours
	7797/7798	2:1	300–500 sf/gal		5–6 hours
Base Coat	FC7500/FC7960	9:1	80 sf/gal	20 WFT/20 DFT	3–4 hours
Topcoat	FC7548/FC7964	2:1	95 sf/gal	13 WFT/12 DFT	NA

Peda-Gard FC Aliphatic

Materials

- Primers: 7780/7781 (280JB) or 7797/7798 (254JB).
- Aggregate: 7992 (66010) 16/30 mesh silica quartz sand.
- Base Coat: FC7500/FC7960 (45063) urethane.
- Wear Coat: FC7510/FC7961 (47PJB) urethane.
- Topcoat: FC7530/FC7963 (57060) urethane.

Average Dry Film Thickness

- 35 dry mils (excluding primer and aggregate).

Application Instructions

Seed and Lock Method

- Primer: Thoroughly mix and apply selected primer and apply at a rate of 300 sf/gal (0.33 gal/100 sf) and allow to cure. 7797/7798 may be applied at up to 500 sf/gal (0.2 gal/100 sf).
- Base Coat: Thoroughly mix and apply FC7500/FC7960 at 88 sf/gal (1.13 gal/100 sf or 18 wet mils) to yield 18 dry mils and allow to cure. The Base Coat must be applied within 24 hours of priming, otherwise clean deck and re-prime as outlined above. Note: Do not leave base coat exposed for more than 5 days.
- Wear Coat: Thoroughly mix and apply FC7510/FC7961 at 200 sf/gal (0.5 gal/100 sf or 8 wet mils) to yield 8 dry mils and immediately broadcast 7992 aggregate, evenly distributed, into wet coating at the rate of 10 lbs/100 sf and allow to cure. Remove loose aggregate by blowing, sweeping or vacuuming.
- Topcoat: Thoroughly mix and apply FC7530/FC7963 at 175 sf/gal (0.57 gal/100 sf or 9 wet mils) to yield 9 dry mils and allow to cure.
- Do not allow traffic on coated surfaces for at least 48 hours at 75°F/23°C, 50% relative humidity.

(continued on next page)

Summary Application Table

Coat	Product	Mix Ratio	Coverage Rate	Mils WFT/DFT	Recoat Time at 75° F/23° C
Primer	7780/7781 7797/7798	4:1 2:1	300 sf/gal 300–500 sf/gal	NA	1.5–2 hours 5–6 hours
Base Coat	FC7500/FC7960	9:1	88 sf/gal	18 WFT/18 DFT	3–4 hours
Wear Coat Aggregate	FC7510/FC7961 7992	3:1	200 sf/gal 10 lbs/100 sf	8 WFT/8 DFT	5–6 hours
Topcoat	FC7530/FC7963	85:15	175 sf/gal	9 WFT/9 DFT	5–6 hours

Seed and Backroll Method

1. Primer: Thoroughly mix and apply selected primer and apply at a rate of 300 sf/gal (0.33 gal/100 sf) and allow to cure. 7797/7798 may be applied at up to 500 sf/gal (0.2 gal/100 sf).
2. Base Coat: Thoroughly mix and apply FC7500/FC7960 at 80 sf/gal (1.25 gal/100 sf or 20 wet mils) to yield 20 dry mils and allow to cure. The Base Coat must be applied within 24 hours of priming, otherwise clean deck and re-prime as outlined above. Note: Do not leave base coat exposed for more than 5 days.
3. Topcoat: Thoroughly mix and apply FC7530/FC7963 at 106 sf/gal (0.94 gal/100 sf or 15 wet mils) to yield 15 dry mils and immediately broadcast 7992 aggregate, evenly distributed, at a rate of approximately 10 lbs/100 sf and backroll to encapsulate aggregate. Allow to cure.
4. Do not allow traffic on coated surfaces for at least 24 hours at 75°F , 50% relative humidity.

Summary Application Table

Coat	Product	Mix Ratio	Coverage Rate	Mils WFT/DFT	Recoat Time at 75° F/23° C
Primer	7780/7781 7797/7798	4:1 2:1	300 sf/gal 300–500 sf/gal	NA	1.5–2 hours 5–6 hours
Base Coat	FC7500/FC7960	9:1	80 sf/gal	20 WFT/20 DFT	3–4 hours
Topcoat Aggregate	FC7530/FC7963 7992	85:15	106 sf/gal 10 lbs/100 sq ft	15 WFT/15 DFT	5–6 hours

Peda-Gard FR

Materials

- Primer: 70714/70715 100% solids epoxy primer.
- Concrete Bedding: prepackaged concrete mix.
- Metal Lathe: 2.7 lbs per square yard, no lighter than 2.5 meshes per inch.
- Aggregate: 7992 (66010) 16/30 mesh silica quartz sand.
- Base Coat: 70410 (45010) series urethane coating.
- Wear Coat: 7430 (57040) series urethane coating.
- Topcoat: 7430 (57040) series urethane coating.

Average Dry Film Thickness

- 32 dry mils (excluding primer).

Application Instructions

1. Mechanically attach metal lathe to plywood substrate. Metal lathe shall comply with the provisions of ASTM C847
2. Primer: Thoroughly mix primer and apply 70714/70715 epoxy at a rate of 250-300 sf/gal to all surfaces. Within 24 hours of application of primer, base coat must be applied. If base coat cannot be applied within 24 hours, inspect surface for contaminants, clean surface as necessary, and re-prime.
3. Base Coat: Thoroughly mix 70410 series and apply at a rate of 60 sf/gal (1.66 gal/100 sf or 26 wet mils), to yield 20 dry mils.
4. Topcoat: Thoroughly mix 7430 series and apply at a rate of 100 sf/gal (1.0 gal/100 sf or 16 wet mils) to yield 12 dry mils. Immediately broadcast aggregate at a rate of approximately 10 lbs/100 sf and backroll to encapsulate aggregate.

Summary Application Table

Coat	Product	Mix Ratio	Coverage Rate	Mils WFT/DFT	Recoat Time at 75°F/23°C
Primer	7780/7781	4:1	300 sf/gal	NA	1.5–2 hours
	7797/7798	2:1	300–500 sf/gal		5–6 hours
Base Coat	FC7500/FC7960	9:1	80 sf/gal	20 WFT/20 DFT	3–4 hours
Topcoat Aggregate	FC7530/FC7963 7992	85:15	106 sf/gal 10 lbs/100 sq ft	15 WFT/15 DFT	5–6 hours

Peda-Gard FC Recreational Deck

Materials

- Primer: Concrete and metal primers as required; contact Neogard for recommendations.
- Aggregate: 20/40 mesh silica quartz sand or other as needed for system.
- Base Coat: FC7500/FC7960 (45063) urethane coating.
- Wear Coat: FC7510/FC7961 (47PJB) urethane coating.
- Topcoat: 57010 Acrylithane HS2

Average Dry Film Thickness

- 49 dry mils (excluding primer).

Application Instructions

1. Primer: Where required, thoroughly mix primer and apply at a rate of 300 sf/gal (0.33 gal/100 sf) to all concrete surfaces. Within 24 hours of application of primer, base coat must be applied. If base coat cannot be applied within 24 hours, inspect surface for contaminants, clean surface as necessary, and re-prime.
2. Base Coat: Thoroughly mix FC7500/FC7960 and apply at a rate of 53 sf/gal, to yield 30 dry mils. Extend base coat over cracks and control joints which have received detail treatment.
3. Wear Coat: Thoroughly mix FC7510/FC7961 and apply at a rate of 200 sf/gal to yield 8 dry mils, and immediately broadcast aggregate, evenly distributed, into wet coating to excess. When dry, remove excess aggregate.

(continued on next page)

4. First Topcoat: When cured, apply Acrylithane HS2 at a rate of 150 sf/gal to yield 6 dry mils..
5. Second Topcoat: When cured, apply Acrylithane HS2 at a rate of 200 sf/gal to yield 5 dry mils..

Summary Application Table

Coat	Product	Mix Ratio	Coverage Rate	Mils WFT/DFT	Recoat Time at 75° F/23° C
Primer	7780/7781	4:1	300 sf/gal	NA	1.5–2 hours
	7797/7798	2:1	300–500 sf/gal		5–6 hours
Base Coat	FC7500/FC7960	9:1	88 sf/gal	18 WFT/18 DFT	3–4 hours
Wear Coat Aggregate	FC7510/FC7961 7992	3:1	200 sf/gal 10 lbs/100 sf	8 WFT/8 DFT	5–6 hours
First Topcoat	Acrylithane HS2	3:1	150 sf/gal	10 WFT/6 DFT	6 hours
Second Topcoat	Acrylithane HS2	3:1	200 sf/gal	8 WFT/5 DFT	NA

Decorative Peda-Gard

Materials

- Primers: 7760/7761 (25100), 7780/7781 (280JB), or 7797/7798 (254JB).
- Aggregate: Contact Neogard for available colors.
 - Series 1: Estes Permacolor HP Quartz Granules (UV-stable), Medium (20/70 mesh).
 - Series 2: Trowel-Rite® (20/40 mesh) inorganic UV-stable quartz aggregate.
- Base Coat: 70410 (45010) or 7430 series (57040) polyurethane.
- Wear Coat: 7430 series (57040) polyurethane.
- Topcoat (five options):
 - 70805/7952 (57020) clear Chemical Resistant Urethane (CRU);
 - 70817/70818 (57070) clear CRU;
 - 70869/70819 (57031) clear Polyaspartic;
 - Acrylithane HS2 (57010);
 - Acrylithane HS4 (645J1).

Note: For lower odor, use 7780/7781 or 7797/7798 primer.

Note: Depending on project conditions, faster turnaround may be achieved with a 70869/70819 Polyaspartic topcoat. If return to service time is critical, contact Neogard for more details.

Average Dry Film Thickness

- 37–40 dry mils (excluding primer and aggregate), dependent on topcoat selected.

Application Instructions

Series 1:

1. Primer: Thoroughly mix and apply selected primer and apply at a rate of 300 sf/gal (0.33 gal/100 sf) and allow to cure. 7797/7798 may be applied at up to 500 sf/gal (0.2 gal/100 sf).
2. Base Coat: Thoroughly mix 70410 or 7430 series and apply at a rate of 60 sf/gal (1.66 gal/100 sf or 26 wet mils), to yield 20 dry mils. Extend base coat over cracks and control joints which have received detail treatment. Note: Do not leave base coat exposed for more than 5 days.

3. Wear Coat: Thoroughly mix 7430 series and apply at a rate of 150 sf/gal (0.66 gal/100 sf or 10 wet mils), to yield 8 dry mils, and immediately broadcast Estes Permacolor HP Quartz Granules, evenly distributed, into wet coating at a rate of approximately 40-50 lbs/100 sf or until refusal. When dry, remove excess aggregate.
 4. First Topcoat: Thoroughly mix and apply one of the following:
 - A. 70817/70818 CRU at a rate of 150 sf/gal (0.66 gal/100 sf or 10 wet mils) to yield 10 dry mils.
 - B. 70869/70819 polyaspartic at a rate of 150 sf/gal (0.66 gal/100 sf or 10 wet mils) to yield 10 dry mils.
 - C. 70805/7952 CRU at a rate of 133 sf/gal (0.75 gal/100 sf or 10 wet mils) to yeild 6 dry mils.
 - D. Acrylithane HS2 at a rate of 133 sf/gal (0.75 gal/100 sf or 10 wet mils) to yeild 6 dry mils.
 - E. Acrylithane HS4 at a rate of 133 sf/gal (0.75 gal/100 sf or 10 wet mils) to yeild 6 dry mils.
 5. Second Topcoat: Thoroughly mix and apply one of the following:
 - A. 70817/70818 CRU at a rate of 200 sf/gal (0.5 gal/100 sf or 8 wet mils) to yield 8 dry mils.
 - B. 70869/70819 polyaspartic at a rate of 200 sf/gal (0.5 gal/100 sf or 8 wet mils) to yield 8 dry mils.
 - C. 70805/7952 CRU at a rate of 200 sf/gal (0.5 gal/100 sf or 8 wet mils) to yeild 5 dry mils.
 - D. Acrylithane HS2 at a rate of 200 sf/gal (0.5 gal/100 sf or 8 wet mils) to yeild 5 dry mils.
 - E. Acrylithane HS4 at a rate of 200 sf/gal (0.5 gal/100 sf or 8 wet mils) to yeild 5 dry mils.
- Note:** Apply topcoats in a cross hatch pattern for best coverage and uniformity of appearance. Depending on the desired texture/finish of the system, additional topcoats may be necessary. The Field Sample will provide confirmation of coverage rates for topcoat.
6. Do not allow traffic on coated surfaces for at least 48 hours at 75°F/23°C, 50% relative humidity.

Summary Application Table

Coat	Product	Mix Ratio	Coverage Rate	Mils WFT/DFT	Recoat Time at 75° F/23° C
Primer	7760/7761	1:1	300 sf/gal	NA	1.5–2 hours
	7780/7781	4:1	300 sf/gal		1.5–2 hours
	7797/7798	2:1	300–500 sf/gal		5–6 hours
Base Coat	70410 or 7430 series	NA	60 sf/gal	26 WFT/20 DFT	12 hours
		NA	60 sf/gal	26 WFT/20 DFT	
Wear Coat Aggregate	7430 series <i>Estes Perma-Color HP Quartz</i>	NA	150 sf/gal <i>50 lbs/100 sf</i>	10 WFT/8 DFT	12 hours
First Topcoat	70817/70818 CRU	1:1	150 sf/gal	10 WFT/10 DFT	8–9 hours
	70869/70819 Polyaspartic	Kit	150 sf/gal	10 WFT/10 DFT	6–8 hours
	70805/7952 CRU	2:1	150 sf/gal	10 WFT/6 DFT	8–9 hours
	Acrylithane HS2	3:1	133 sf/gal	10 WFT/6 DFT	6 hours
	Acrylithane HS4	4:1	133 sf/gal	10 WFT/6 DFT	6 hours
Second Topcoat	70817/70818 CRU	1:1	200 sf/gal	8 WFT/8 DFT	NA
	70869/70819 Polyaspartic	Kit	200 sf/gal	8 WFT/8 DFT	
	70805/7952 CRU	2:1	200 sf/gal	8 WFT/5 DFT	
	Acrylithane HS2	3:1	200 sf/gal	8 WFT/5 DFT	
	Acrylithane HS4	4:1	200 sf/gal	8 WFT/5 DFT	

Series 2:

1. Primer: Thoroughly mix and apply selected primer and apply at a rate of 300 sf/gal (0.33 gal/100 sf) and allow to cure. 7797/7798 may be applied at up to 500 sf/gal (0.2 gal/100 sf).

(continued on next page)

2. Base Coat: Thoroughly mix 70410 or 7430 series and apply at a rate of 60 sf/gal (1.66 gal/100 sf or 26 wet mils), to yield 20 dry mils. Extend base coat over cracks and control joints which have received detail treatment. Note: Do not leave base coat exposed for more than 5 days.
3. Wear Coat: Thoroughly mix 7430 series and apply at a rate of 120 sf/gal (0.83 gal/100 sf or 13 wet mils), to yield 10 dry mils, and immediately broadcast Trowel-Rite® inorganic UV-stable quartz aggregate, evenly distributed, into wet coating at a rate of approximately 50 lbs/100 sf or until refusal. When dry, remove excess granules.
4. First Topcoat: Thoroughly mix and apply one of the following:
 - A. 70817/70818 CRU at a rate of 150 sf/gal (0.66 gal/100 sf or 10 wet mils) to yield 10 dry mils.
 - B. 70869/70819 polyaspartic at a rate of 150 sf/gal (0.66 gal/100 sf or 10 wet mils) to yield 10 dry mils.
 - C. 70805/7952 CRU at a rate of 133 sf/gal (0.75 gal/100 sf or 10 wet mils) to yeild 6 dry mils.
 - D. Acrylithane HS2 at a rate of 133 sf/gal (0.75 gal/100 sf or 10 wet mils) to yeild 6 dry mils.
 - E. Acrylithane HS4 at a rate of 133 sf/gal (0.75 gal/100 sf or 10 wet mils) to yeild 6 dry mils.
5. Second Topcoat: Thoroughly mix and apply one of the following:
 - A. 70817/70818 CRU at a rate of 200 sf/gal (0.5 gal/100 sf or 8 wet mils) to yield 8 dry mils.
 - B. 70869/70819 polyaspartic at a rate of 200 sf/gal (0.5 gal/100 sf or 8 wet mils) to yield 8 dry mils.
 - C. 70805/7952 CRU at a rate of 200 sf/gal (0.5 gal/100 sf or 8 wet mils) to yeild 5 dry mils.
 - D. Acrylithane HS2 at a rate of 200 sf/gal (0.5 gal/100 sf or 8 wet mils) to yeild 5 dry mils.
 - E. Acrylithane HS4 at a rate of 200 sf/gal (0.5 gal/100 sf or 8 wet mils) to yeild 5 dry mils.

Note: Apply topcoats in a cross hatch pattern for best coverage and uniformity of appearance. Depending on the desired texture/finish of the system, additional topcoats may be necessary. The Field Sample will provide confirmation of coverage rates for topcoat.

6. Do not allow traffic on coated surfaces for at least 48 hours at 75°F/23°C, 50% relative humidity.

Summary Application Table

Coat	Product	Mix Ratio	Coverage Rate	Mils WFT/DFT	Recoat Time at 75° F/23° C
Primer	7760/7761	1:1	300 sf/gal	NA	1.5–2 hours
	7780/7781	4:1	300 sf/gal		1.5–2 hours
	7797/7798	2:1	300–500 sf/gal		5–6 hours
Base Coat	70410 or 7430 series	NA	60 sf/gal	26 WFT/20 DFT	12 hours
		NA	60 sf/gal	26 WFT/20 DFT	
Wear Coat Aggregate	7430 series Trowel-Rite®	NA	120 sf/gal 50 lbs/100 sf	13 WFT/10 DFT	12 hours
First Topcoat	70817/70818 CRU	1:1	150 sf/gal	10 WFT/10 DFT	8–9 hours
	70869/70819 Polyaspartic	Kit	150 sf/gal	10 WFT/10 DFT	6–8 hours
	70805/7952 CRU	2:1	150 sf/gal	10 WFT/6 DFT	8–9 hours
	Acrylithane HS2	3:1	133 sf/gal	10 WFT/6 DFT	6 hours
	Acrylithane HS4	4:1	133 sf/gal	10 WFT/6 DFT	6 hours
Second Topcoat	70817/70818 CRU	1:1	200 sf/gal	8 WFT/8 DFT	NA
	70869/70819 Polyaspartic	Kit	200 sf/gal	8 WFT/8 DFT	
	70805/7952 CRU	2:1	200 sf/gal	8 WFT/5 DFT	
	Acrylithane HS2	3:1	200 sf/gal	8 WFT/5 DFT	
	Acrylithane HS4	4:1	200 sf/gal	8 WFT/5 DFT	

Decorative Peda-Gard FC

Materials

- Primers: 7780/7781 (280JB) or 7797/7798 (254JB).
- Aggregate: Contact Neogard for available colors.
 - Series 1: Estes Permacolor HP Quartz Granules (UV stable), Medium (20/70 mesh).
 - Series 2: Trowel-Rite® (20/40 mesh) inorganic UV stable quartz aggregate.
- Base Coat: FC7500/FC7960 (45063) urethane.
- Wear Coat: FC7510/FC7961 (47PJB) urethane.
- Topcoat (choose one):
 - 70817/70818 Chemical Resistant Urethane (CRU) (57070).
 - 70869/70819 Polyaspartic (57031).

Note: Depending on project conditions, faster turnaround may be achieved with a 70869/70819 Polyaspartic topcoat. If return to service time is critical, contact Neogard for more details.

Average Dry Film Thickness

- 37–40 dry mils (excluding primer and aggregate), dependent on topcoat selected.

Application Instructions

Series 1:

1. Primer: Thoroughly mix and apply selected primer and apply at a rate of 300 sf/gal (0.33 gal/100 sf) and allow to cure. 7797/7798 may be applied at up to 500 sf/gal (0.2 gal/100 sf).
2. Base Coat: Thoroughly mix and apply FC7500/FC7960 at 80 sf/gal (1.25 gal/100 sf or 20 wet mils) to yield 20 dry mils and allow to cure. The Base Coat must be applied within 24 hours of priming, otherwise clean deck and re-prime as outlined above. Note: Do not leave base coat exposed for more than 5 days.
3. Wear Coat: Thoroughly mix and apply FC7510/FC7961 at 160 sf/gal (0.5 gal/100 sf or 8 wet mils) to yield 8 dry mils and immediately broadcast aggregate, evenly distributed, into wet coating until refusal (approximately 50 lbs/100 sf) and allow to cure. Remove loose aggregate by blowing, sweeping or vacuuming.
4. First Topcoat: Thoroughly mix and apply 70817/70818 CRU or 70869/70819 Polyaspartic at 150 sf/gal (0.66 gal/100 sf or 10 wet mils) to yield 10 dry mils. Allow to cure tack-free.
5. Second Topcoat: Thoroughly mix and apply 70817/70818 CRU or 70869/70819 Polyaspartic at 200 sf/gal (0.5 gal/100 sf or 8 wet mils) to yield 8 dry mils. Allow to cure tack-free.

Note: Apply topcoats in a cross hatch pattern for best coverage and uniformity of appearance. Depending on the desired texture/finish of the system, additional topcoats may be necessary. The Field Sample will provide confirmation of coverage rates for topcoat.

6. Do not allow traffic on coated surfaces for at least 48 hours at 75°F/23°C, 50% relative humidity.

(continued on next page)

Summary Application Table

Coat	Product	Mix Ratio	Coverage Rate	Mils WFT/DFT	Recoat Time at 75° F/23° C
Primer	7780/7781	4:1	300 sf/gal	NA	1.5–2 hours
	7797/7798	2:1	300–500 sf/gal		5–6 hours
Base Coat	FC7500/FC7960	9:1	80 sf/gal	20 WFT/20 DFT	3–4 hours
Wear Coat Aggregate	FC7510/FC7961 or FC7540/FC7964 <i>Broadcast Medium Quartz</i>	3:1 2:1	160 sf/gal 160 sf/gal 50 lbs/100 sf	10 WFT/10 DFT	5–6 hours
First Topcoat	70817/70818 CRU	1:1	150 sf/gal	10 WFT/10 DFT	8–9 hours
	70869/70819 Polyaspartic	Kit	150 sf/gal	10 WFT/10 DFT	6–8 hours
Second Topcoat	70817/70818 CRU	1:1	200 sf/gal	8 WFT/8 DFT	NA
	70869/70819 Polyaspartic	Kit	200 sf/gal	8 WFT/8 DFT	

Series 2:

1. Primer: Thoroughly mix and apply selected primer and apply at a rate of 300 sf/gal (0.33 gal/100 sf) and allow to cure. 7797/7798 may be applied at up to 500 sf/gal (0.2 gal/100 sf).
2. Base Coat: Thoroughly mix and apply FC7500/FC7960 at 80 sf/gal (1.25 gal/100 sf or 20 wet mils) to yield 20 dry mils and allow to cure. The Base Coat must be applied within 24 hours of priming, otherwise clean deck and re-prime as outlined above.
3. Wear Coat: Thoroughly mix and apply FC7510/FC7961 at 133 sf/gal (0.66 gal/100 sf or 12 wet mils) to yield 12 dry mils and immediately broadcast aggregate, evenly distributed, into wet coating until refusal (approximately 50 lbs/100 sf) and allow to cure. Remove loose aggregate by blowing, sweeping or vacuuming.
4. First Topcoat: Thoroughly mix and apply 70817/70818 CRU or 70869/70819 Polyaspartic at 133 sf/gal (0.75 gal/100 sf or 12 wet mils) to yield 12 dry mils. Allow to cure tack-free.
5. Second Topcoat: Thoroughly mix and apply 70817/70818 CRU or 70869/70819 Polyaspartic at 200 sf/gal (0.5 gal/100 sf or 8 wet mils) to yield 8 dry mils. Allow to cure tack-free.

Note: Apply topcoats in a cross hatch pattern for best coverage and uniformity of appearance. Depending on the desired texture/finish of the system, additional topcoats may be necessary. The Field Sample will provide confirmation of coverage rates for topcoat.

6. Do not allow traffic on coated surfaces for at least 48 hours at 75°F/23°C, 50% relative humidity.

Summary Application Table

Coat	Product	Mix Ratio	Coverage Rate	Mils WFT/DFT	Recoat Time at 75° F/23° C
Primer	7780/7781	4:1	300 sf/gal	NA	1.5–2 hours
	7797/7798	2:1	300–500 sf/gal		5–6 hours
Base Coat	FC7500/FC7960	9:1	80 sf/gal	20 WFT/20 DFT	3–4 hours
Wear Coat Aggregate	FC7510/FC7961 or FC7540/FC7964 <i>Trowel-Rite®</i>	3:1 2:1	133 sf/gal 133 sf/gal 50 lbs/100 sf	12 WFT/12 DFT	5–6 hours
First Topcoat	70817/70818 CRU	1:1	133 sf/gal	12 WFT/12 DFT	8–9 hours
	70869/70819 Polyaspartic	Kit	133 sf/gal	12 WFT/12 DFT	6–8 hours
Second Topcoat	70817/70818 CRU	1:1	200 sf/gal	8 DFT/8 WFT	NA
	70869/70819 Polyaspartic	Kit	200 sf/gal	8 DFT/8 WFT	

Decorative Peda-Gard Flake

Materials

- Primers: 7760/7761 (25100), 7780/7781 (280JB), or 7797/7798 (254JB).
- Aggregate: UV stable flakes.
- Base Coat: 70410 (45010) or 7430 series (57040) polyurethane coating.
- Wear Coat: 7470 series (47LJB) polyurethane coating.
- Topcoat (five options):
 - 70805/7952 (57020) clear Chemical Resistant Urethane (CRU);
 - 70817/70818 (57070) clear CRU;
 - 70869/70819 (57031) clear Polyaspartic;
 - Acrylithane HS2 (57010);
 - Acrylithane HS4 (645J1).

Note: For lower odor, use 7780/7781 or 7797/7798 primer.

Note: Depending on project conditions, faster turnaround may be achieved with a 70869/70819 Polyaspartic topcoat. If return to service time is critical, contact Neogard for more details.

Average Dry Film Thickness

- 40–42 dry mils (excluding primer and aggregate) dependent on topcoat selected.

Application Instructions

1. Primer: Thoroughly mix and apply selected primer and apply at a rate of 300 sf/gal (0.33 gal/100 sf) and allow to cure. 7797/7798 may be applied at up to 500 sf/gal (0.2 gal/100 sf).
2. Base Coat: Thoroughly mix 70410 or 7430 series and apply at a rate of 60 sf/gal (1.66 gal/100 sf or 26 wet mils), to yield 20 dry mils. Extend base coat over cracks and control joints which have received detail treatment. Note: Do not leave base coat exposed for more than 5 days.
3. Wear Coat: Thoroughly mix 7470 series wear coat material and apply at a rate of 120 sf/gal (0.83 gal/100 sf or 13 wet mils), to yield 10 dry mils, and immediately broadcast flakes into wet coating until refusal (approximately 25 lbs/100 sf). When dry, remove excess flakes and lightly abrade flake surface with palm sander utilizing 80 grit sand paper or use a Bully Tool® Pro Grade Floor Scraper or similar tool. Remove debris by blowing, sweeping, or vacuuming.
4. First Topcoat: Thoroughly mix and apply one of the following:
 - A. 70817/70818 CRU at a rate of 150 sf/gal (0.66 gal/100 sf or 10 wet mils) to yield 10 dry mils.
 - B. 70869/70819 polyaspartic at a rate of 150 sf/gal (0.66 gal/100 sf or 10 wet mils) to yield 10 dry mils.
 - C. 70805/7952 CRU at a rate of 133 sf/gal (0.75 gal/100 sf or 10 wet mils) to yeild 6 dry mils.
 - D. Acrylithane HS2 at a rate of 133 sf/gal (0.75 gal/100 sf or 10 wet mils) to yeild 6 dry mils.
 - E. Acrylithane HS4 at a rate of 133 sf/gal (0.75 gal/100 sf or 10 wet mils) to yeild 6 dry mils.

(continued on next page)

5. Second Topcoat: Thoroughly mix and apply one of the following:
 - A. 70817/70818 CRU at a rate of 200 sf/gal (0.5 gal/100 sf or 8 wet mils) to yield 8 dry mils.
 - B. 70869/70819 polyaspartic at a rate of 200 sf/gal (0.5 gal/100 sf or 8 wet mils) to yield 8 dry mils.
 - C. 70805/7952 CRU at a rate of 200 sf/gal (0.5 gal/100 sf or 8 wet mils) to yeild 5 dry mils.
 - D. Acrylithane HS2 at a rate of 200 sf/gal (0.5 gal/100 sf or 8 wet mils) to yeild 5 dry mils.
 - E. Acrylithane HS4 at a rate of 200 sf/gal (0.5 gal/100 sf or 8 wet mils) to yeild 5 dry mils.

Note: Apply topcoats in a cross hatch pattern for best coverage and uniformity of appearance. Depending on the desired texture/finish of the system, additional topcoats may be necessary. The Field Sample will provide confirmation of coverage rates for topcoat.

6. Do not allow traffic on coated surfaces for at least 48 hours at 75°F/23°C, 50% relative humidity.

Summary Application Table

Coat	Product	Mix Ratio	Coverage Rate	Mils WFT/DFT	Recoat Time at 75° F/23° C
Primer	7760/7761	1:1	300 sf/gal	NA	1.5–2 hours
	7780/7781	4:1	300 sf/gal		1.5–2 hours
	7797/7798	2:1	300–500 sf/gal		5–6 hours
Base Coat	70410 or 7430 series	NA	60 sf/gal	26 WFT/20 DFT	12 hours
		NA	60 sf/gal	26 WFT/20 DFT	
Wear Coat Aggregate	7470 series <i>UV-Stable Flakes</i>	NA	120 sf/gal <i>25 lbs/100 sf</i>	13 WFT/10 DFT	16 hours
First Topcoat	70817/70818 CRU	1:1	150 sf/gal	10 WFT/10 DFT	8–9 hours
	70869/70819 Polyaspartic	Kit	150 sf/gal	10 WFT/10 DFT	6 hours
	70805/7952 CRU	2:1	150 sf/gal	10 WFT/6 DFT	8–9 hours
	Acrylithane HS2	3:1	133 sf/gal	10 WFT/6 DFT	6 hours
	Acrylithane HS4	4:1	133 sf/gal	10 WFT/6 DFT	6 hours
Second Topcoat	70817/70818 CRU	1:1	200 sf/gal	8 WFT/8 DFT	NA
	70869/70819 Polyaspartic	Kit	200 sf/gal	8 WFT/8 DFT	
	70805/7952 CRU	2:1	200 sf/gal	8 WFT/5 DFT	
	Acrylithane HS2	3:1	200 sf/gal	8 WFT/5 DFT	
	Acrylithane HS4	4:1	200 sf/gal	8 WFT/5 DFT	

Decorative Peda-Gard FC Flake

Materials

- Primers: 7780/7781 (280JB) or 7797/7798 (254JB).
- Aggregate: UV stable flakes.
- Base Coat: 70410 (45010) or 7430 series (57040) polyurethane.
- Wear Coat: 7470 series (47LJB) polyurethane.
- Topcoat (choose one):
 - 70805/7952 Chemical Resistant Urethane (CRU) (57020).
 - 70817/70818 CRU (57070).

Average Dry Film Thickness

- 40–42 dry mils (excluding primer and aggregate) dependent on topcoat selected.

Application Instructions

1. Primer: Thoroughly mix and apply selected primer and apply at a rate of 300 sf/gal (0.33 gal/100 sf) and allow to cure. 7797/7798 may be applied at up to 500 sf/gal (0.2 gal/100 sf).
2. Base Coat: Thoroughly mix and apply FC7500/FC7960 at 80 sf/gal (1.25 gal/100 sf or 20 wet mils) to yield 20 dry mils and allow to cure. The Base Coat must be applied within 24 hours of priming, otherwise clean deck and re-prime as outlined above. Note: Do not leave base coat exposed for more than 5 days.
3. Wear Coat: Thoroughly mix and apply FC7540/FC7964 at 133 sf/gal (0.75 gal/100 sf or 12 wet mils) to yield 10 dry mils and immediately broadcast flakes into wet coating until refusal at a rate of approximately 25 lbs/100 sf and allow to cure. Remove loose aggregate by blowing, sweeping or vacuuming.
4. First Topcoat: Thoroughly mix and apply 70817/70818 CRU or 70869/70819 Polyaspartic at 150 sf/gal (0.66 gal/100 sf or 10 wet mils) to yield 10 dry mils. Allow to cure tack-free.
5. Second Topcoat: Thoroughly mix and apply 70817/70818 CRU or 70869/70819 Polyaspartic at 200 sf/gal (0.5 gal/100 sf or 8 wet mils) to yield 8 dry mils. Allow to cure tack-free.

Note: Apply topcoats in a cross hatch pattern for best coverage and uniformity of appearance. Depending on the desired texture/finish of the system, additional topcoats may be necessary. The Field Sample will provide confirmation of coverage rates for topcoat.

6. Do not allow pedestrian traffic on coated surfaces for at least 48 hours at 75°F/23°C, 50% relative humidity.

Summary Application Table

Coat	Product	Mix Ratio	Coverage Rate	Mils WFT/DFT	Recoat Time at 75°F/23°C
Primer	7780/7781	4:1	300 sf/gal	NA	1.5–2 hours
	7797/7798	2:1	300–500 sf/gal		5–6 hours
Base Coat	FC7500/FC7960	9:1	80 sf/gal	20 WFT/20 DFT	3–4 hours
Wear Coat Aggregate	FC7540/FC7964 <i>UV-stable flakes</i>	2:1	120 sf/gal <i>25 lbs/100 sf</i>	13 WFT/12 DFT	3–4 hours
First Topcoat	70817/70818 CRU	1:1	150 sf/gal	10 WFT/10 DFT	8–9 hours
	70869/70819 Polyaspartic	Kit	150 sf/gal	10 WFT/10 DFT	6–8 hours
Second Topcoat	70817/70818 CRU	1:1	200 sf/gal	8 WFT/8 DFT	NA
	70869/70819 Polyaspartic	Kit	200 sf/gal	8 WFT/8 DFT	

TrafficTuff

Materials

- Epoxy: 70714/70715-09 (45062) clear.
- Aggregate: 7992 (16/30 mesh) silica quartz sand.
- Epoxy Seal Coat: 70714/70715-09 (45062) pigmented.
- Exterior Optional Coat (choose one):
 - 70805/7952 (57020) pigmented chemical resistant urethane (CRU).
 - Acrylithane HS2 (57010).

(continued on next page)

Average Dry Film Thickness

- 28 dry mils (excluding aggregate)
- 33 dry mils with Exterior Optional Coat (excluding aggregate)

Application Instructions

1. Base Coat: Mix 70714/70715-09 clear at a ratio of 2:1 by volume. Apply at a rate of 100 sf/gal (16 mils wft) to prepared substrate with a notched squeegee, notched trowel or short nap (3/8") phenolic core roller. Back roll with a short-napped phenolic core roller.
2. Aggregate: Broadcast 7992 blended aggregate into wet epoxy base coat until refusal at a rate of approximately 15 lbs/100sf. Maintain a one to two foot wet edge without any aggregate to allow for a smooth transition to the next pass of neat epoxy. Allow to cure 8–9 hours at 75°F/23°C. Remove excess aggregate.
3. Topcoat (choose one):
 - A. UV-resistant, exterior application: Thoroughly mix FC7540/FC7964 and apply at a rate of approximately 120 sf/gal to yield 12 dry mils.
 - B. Non-UV resistant, interior application: Thoroughly mix FC7510/FC7961 and apply at a rate of approximately 133 sf/gal to yield 12 dry mils.
 - C. Non-UV resistant, interior application: Thoroughly mix 70714/70715 and apply at a rate of 133 sf/gal to yield 12 dry mils.

Summary Application Table

Coat	Product	Mix Ratio	Coverage Rate	Mils WFT/DFT	Recoat Time at 75°F/23°C
Base Coat Aggregate	70714/70715-09 7992	2:1	100 sf/gal 15 lbs/100sf	16 WFT/16 DFT	8–9 hours
Topcoat (choose one)	FC7540/FC7964 FC7510/FC7961 70714/70715	2:1 3:1 2:1	120 sf/gal 133 sf/gal 133 sf/gal	13 WFT/12 DFT 12 WFT/12 DFT 12 WFT/12 DFT	NA

Epoxy Broadcast Overlay

Materials

- Primer: See recommended primers in the Summary Application Tables below.
- Sealant: 70991 urethane sealant (47XJB).
- Aggregates:
 - 7992-U 12/20 Mesh Aggregate (66EJB).
 - Grade 65-8 flint, 4-30 mesh.
 - Black Beauty, Medium.
 - #16 Aluminum Oxide.
- Epoxy Wear Coat/Topcoat: 70714/70715-09 series (45062).
- Urethane Topcoat: FC7540/FC7964 (47QJB).

Average Dry Film Thickness

- Series 1: 60 dry mils (excluding primer and aggregate)
- Series 2: 50 dry mils (excluding primer and aggregate)
- Series 3: 36 dry mils (excluding primer and aggregate)

Application Instructions

Series 1—Extreme Service:

1. Primer: Thoroughly mix primer and apply at a rate of 300 sf/gal (0.33 gal/100 sf) to all concrete surfaces. Within 24 hours of application of primer, wear coat must be applied. If wear coat cannot be applied within 24 hours, inspect surface for contaminants, clean surface as necessary, and re-prime.
2. Wear Coat: Thoroughly mix 70714/70715-09 and apply at a rate of 26 sf/gal (3.75 gal/100 sf, 60 wet mils) to yield 60 dry mils, and immediately broadcast 65-8 flint aggregate to rejection, into wet coating at an approximate rate of 90 lbs/100 sf. When dry, remove excess aggregate.

Summary Application Table

Coat	Product	Mix Ratio	Coverage Rate	Mils WFT/DFT	Recoat Time at 75°F/23°C
Primer	70714/70715-09 70714/70715	2:1 2:1	300 sf/gal	NA	8–9 hours
Wear Coat Aggregate	70714/70715-09 65-8 Flint	2:1	26 sf/gal 90 lbs/100sf	60/60	NA

Series 2—Heavy Duty Service:

1. Primer (Optional): Thoroughly mix primer and apply at a rate of 300 sf/gal (0.33 gal/100 sf) to all concrete surfaces. Within 24 hours of application of primer, wear coat must be applied. If wear coat cannot be applied within 24 hours, inspect surface for contaminants, clean surface as necessary, and re-prime.
2. Wear Coat: Thoroughly mix 70714/70715-09 and apply at a rate of 32 sf/gal (3.125 gal/100 sf, 50 wet mils) to yield 50 dry mils, and immediately broadcast aggregate to rejection, into wet coating at an approximate rate of 60 lbs/100 sf. When dry, remove excess aggregate. For a double broadcast system, repeat this step.

Summary Application Table

Coat	Product	Mix Ratio	Coverage Rate	Mils WFT/DFT	Recoat Time at 75°F/23°C
Primer	70714/70715-09 or 70714/70715	2:1 2:1	300 sf/gal	NA	8–9 hours
Wear Coat Aggregate	70714/70715-09 7992-U or Black Beauty or #16 Aluminum Oxide	2:1	32 sf/gal 60 lbs/100 sf	50 WFT/50 DFT	NA

Series 3—Moderate to Heavy Duty Service:

1. Base Coat: Thoroughly mix 70714/70715-09 and apply at a rate of 80 sf/gal (1.25 gal/100 sf, 20 wet mils) to yield 20 dry mils, and immediately broadcast aggregate to rejection, into wet coating at an approximate rate of 25-30 lbs/100 sf. When dry, remove excess aggregate.

(continued on next page)

2. Topcoat:

- A. Epoxy: Thoroughly mix and apply clear or pigmented 70714/70715-09 at a rate of 100 sf/gal (1.0 gal/100 sf, 16 wet mils) to yield 16 dry mils.
- B. Urethane: Thoroughly mix and apply FC7540/FC7964 at a rate of 90 sf/gal (1.1 gal/100 sf, 17 wet mils) to yield 16 dry mils.

Summary Application Table

Coat	Product	Mix Ratio	Coverage Rate	Mils WFT/DFT	Recoat Time at 75°F/23°C
Base	70714/70715-09	2:1	80 sf/gal	20 WFT/20 DFT	8–9 hours
Topcoat	70714/70715-09 or FC7540/FC7964	2:1 2:1	100 sf/gal 90 sf/gal	16 WFT/16 DFT 17 WFT/16 DFT	NA

Peda-Gard M

Materials

- Primers: 7760/7761 (25100), 7780/7781 (280JB), or 7797/7798 (254JB).
- Aggregate: 7992 (66010) 16/30 mesh silica quartz sand.
- Base Coat: FC7500/FC7960 (45063) urethane coating.
- Topcoat (choose one):
 - FC7510/FC7961 (47PJB) polyurethane.
 - 70714/70715-09 (45062) 100% solids pigmented epoxy.

Note: For lower odor, use 7780/7781 or 7797/7798 primer.

Note: Topcoat shown is for non-UV exposed applications only.

Average Dry Film Thickness

- 32 dry mils (excluding primer and aggregate).

Application Instructions

1. Primer: Thoroughly mix and apply selected primer and apply at a rate of 300 sf/gal (0.33 gal/100 sf) and allow to cure. 7797/7798 may be applied at up to 500 sf/gal (0.2 gal/100 sf).
2. Base Coat: Thoroughly mix and apply FC7500/FC7960 at 80 sf/gal (1.25 gal/100 sf or 20 wet mils) to yield 20 dry mils and allow to cure. The Base Coat must be applied within 24 hours of priming, otherwise clean deck and re-prime as outlined above. Note: Do not leave base coat exposed for more than 5 days.
3. Topcoat: Thoroughly mix and apply FC7510/FC7961 or 70714/70715-09 at 133 sf/gal (0.75 gal/100 sf or 12 wet mils) to yield 12 dry mils. Immediately broadcast 7992 aggregate, evenly distributed, into wet coating at the rate of 10 lbs/100 sf and backroll.
4. Do not allow traffic on coated surfaces for at least 48 hours at 75°F/23°C, 50% relative humidity.

Summary Application Table

Coat	Product	Mix Ratio	Coverage Rate	Mils WFT/DFT	Recoat Time at 75°F/23°C
Primer	7780/7781 or 7797/7798	4:1 2:1	300 sf/gal 300–500 sf/gal	NA	1.5–2 hours 5–6 hours
Base Coat	FC7500/FC7960	9:1	80 sf/gal	20 WFT/20 DFT	3–4 hours
Topcoat	FC7510/FC7961 or 70714/70715-09	3:1 2:1	133 sf/gal 133 sf/gal	12 WFT/12 DFT 12 WFT/12 DFT	5–6 hours 8–9 hours
Aggregate	7992		10 lbs/100 sq ft		

Peda-Gard TS

Materials

- Primers: 7760/7761 (25100), 7780/7781 (280JB), or 7797/7798 (254JB).
- Aggregate: 7992 (66010) silica quartz sand.
- Base Coat: 7430 series (57040) urethane.
- Wear Coat: 7430 series (57040) urethane.

Note: For lower odor, use 7780/7781 or 7797/7798 primer.

Average Dry Film Thickness

- 36 dry mils (excluding primer and aggregate)

Application Instructions

1. Primer: Thoroughly mix and apply selected primer and apply at a rate of 300 sf/gal (0.33 gal/100 sf) and allow to cure. 7797/7798 may be applied at up to 500 sf/gal (0.2 gal/100 sf).
2. First Base Coat: Thoroughly mix and apply 7430 series at 80 sf/gal (1.25 gal/100 sf or 20 wet mils) to yield 15 dry mils and allow to cure. The Base Coat must be applied within 24 hours of priming, otherwise clean deck and re-prime as outlined above.
3. Second Base Coat: Thoroughly mix and apply 7430 series at 80 sf/gal (1.25 gal/100 sf or 20 wet mils) to yield 15 dry mils and allow to cure. Note: Do not leave second base coat exposed for more than 5 days.
4. Wear Coat: Thoroughly mix and apply 7430 series at 200 sf/gal (0.5 gal/100 sf or 8 wet mils) to yield 6 dry mils and immediately broadcast 7992 aggregate, evenly distributed, into wet coating at a rate of 10 lbs/100 sf or until solidly textured and allow to cure. Remove loose aggregate by blowing, sweeping or vacuuming.
5. Do not allow traffic on coated surfaces for at least 48 hours at 75°F/23°C, 50% relative humidity.

(continued on next page)

Summary Application Table

Coat	Product	Mix Ratio	Coverage Rate	Mils WFT/DFT	Recoat Time at 75° F/23° C
Primer	7780/7781 or 7797/7798	4:1 2:1	300 sf/gal 300–500 sf/gal	NA	1.5–2 hours 5–6 hours
Base Coat	7430 series	NA	80 sf/gal	20 WFT/15 DFT	12 hours
2nd Base Coat	7430 series	NA	80 sf/gal	20 WFT/15 DFT	12 hours
Wear Coat Aggregate	7430 series 7992	NA	200 sf/gal 10 lbs/100 sq ft	8 WFT/6 DFT	12 hours

Peda-Gard TS Detail Drawing

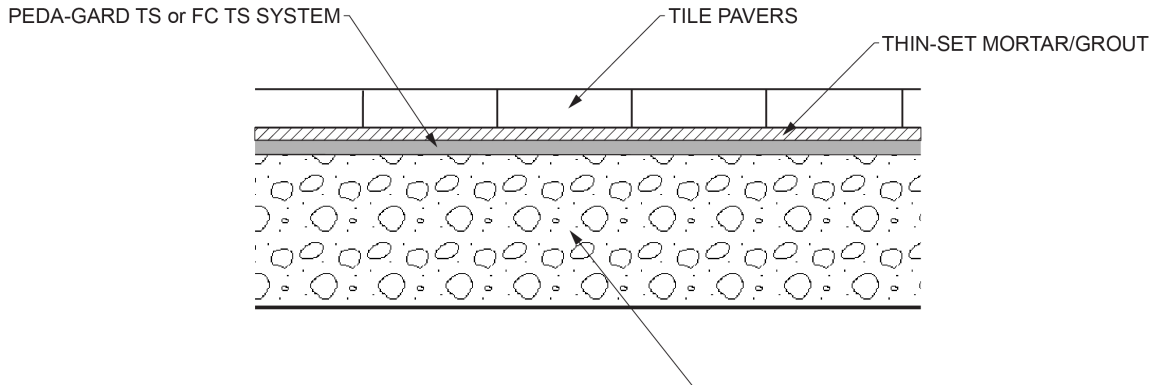

Peda-Gard FC TS

Materials

- Primers: 7780/7781 (280JB) or 7797/7798 (254JB).
- Aggregate: 7992 (66010) 16/30 mesh or 7992-U (66EJB) 12/20 mesh silica quartz sand.
- Base Coat: FC7500/FC7960 (45063) urethane.
- Wear Coat: FC7510/FC7961 (47PJB) urethane.

Average Dry Film Thickness

- 36 dry mils (excluding primer and aggregate).

Application Instructions

1. Primer: Thoroughly mix and apply selected primer and apply at a rate of 300 sf/gal (0.33 gal/100 sf) and allow to cure. 7797/7798 may be applied at up to 500 sf/gal (0.2 gal/100 sf).
2. Base Coat: Thoroughly mix and apply FC7500/FC7960 at 60 sf/gal (1.66 gal/100 sf or 26 wet mils) to yield 26 dry mils and allow to cure. The Base Coat must be applied within 24 hours of priming, otherwise clean deck and re-prime as outlined above. Note: Do not leave base coat exposed for more than 5 days.
3. Wear Coat: Thoroughly mix and apply FC7510/FC7961 at 160 sf/gal (0.62 gal/100 sf or 10 wet mils) to yield 10 dry mils and immediately broadcast 7992 aggregate, evenly distributed, into wet coating at the rate of 10 lbs/100 sf and allow to cure. Remove loose aggregate by blowing, sweeping or vacuuming.

4. Do not allow traffic on coated surfaces for at least 48 hours at 75°F/23°C, 50% relative humidity.

Summary Application Table

Coat	Product	Mix Ratio	Coverage Rate	Mils WFT/DFT	Recoat Time at 75°F/23°C
Primer	7780/7781 or 7797/7798	4:1 2:1	300 sf/gal 300–500 sf/gal	NA	1.5–2 hours 5–6 hours
Base Coat	FC7500/FC7960	9:1	60 sf/gal	26 WFT/26 DFT	3–4 hours
Wear Coat Aggregate	FC7510/FC7961 7992	3:1	160 sf/gal 10 lbs/100 sf	10 WFT/10 DFT	5–6 hours

Peda-Gard FC TS Detail Drawing

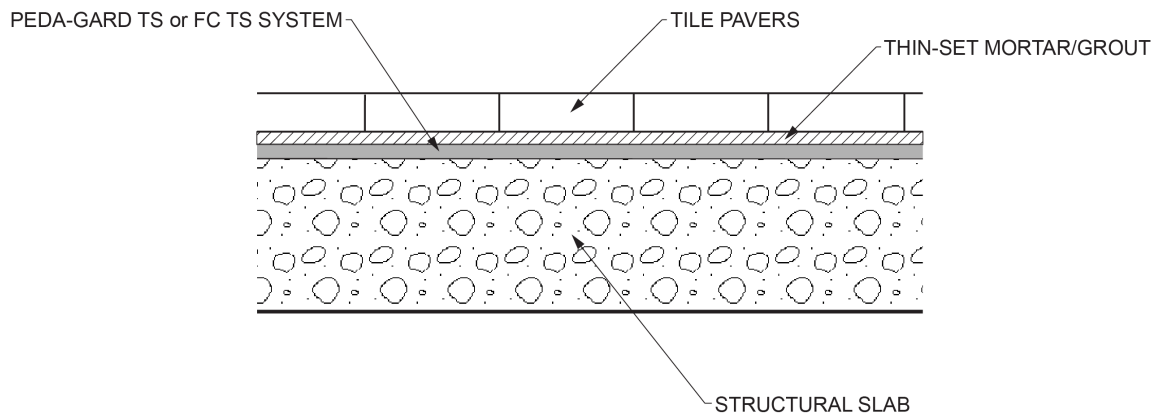

Pool-Gard C

Materials

- Primer: 7740/7741 (252JB).
- Base Coat: 7825/7821 (47NJ9/ 947JB) polyurethane coating, black in color.
- Topcoat: 7825/7821 (47NJ9/ 947JB) polyurethane coating, black in color.
- Exterior Finish Primer: 33014/99951 (15059/ 95041) Ureprime HS4 epoxy urethane.
- Exterior Finish Coat: Acrylithane HS2 or HS4 series urethane enamel.

Average Dry Film Thickness

- 48 dry mils (excluding exterior primer and finish coats).

Application Instructions

1. Prime concrete with 7740/7741 epoxy primer mix at a rate of 200 sf/gal (0.5 gal/100 sf) and allow to cure.
2. Base Coat: Thoroughly mix and apply 7825/7821 at 66 sf/gal (1.5 gal/100 sf or 24 wet mils) to yield 24 dry mils and allow to cure. The Base Coat must be applied within 24 hours of priming, otherwise clean deck and re-prime as outlined above.

Note: Do not leave base coat exposed for more than 5 days.

3. Topcoat: Thoroughly mix and apply 7825/7821 at 66 sf/gal (1.5 gal/100 sf or 24 wet mils) to yield 24 dry mils and allow to cure.

Note: Exterior applications exposed to UV must be coated with Ureprime HS4 series primer and exterior finish coat.

4. Exterior Finish Primer: Thoroughly mix and apply 33014/99951 Ureprime HS4 at a rate of 300 sf/gal (0.33 gal/100 sf) over the final coat of cured 7825/7821.
5. Exterior Finish Coats: Thoroughly mix and apply two coats of Acrylithane series urethane enamel at the rate of 200 sf/gal (0.5 gal/100 sf or 8 wet mils) to yield 4–5 dry mils per coat.

Note: If more than 24 hours lapse between finish coat applications, the first finish coat must be sanded prior to second finish coat application. Repeat this step for additional coats.

Caution: Allow entire Pool-Gard C coating system to cure for a minimum of 10 days prior to filling pool.

Summary Application Table

Coat	Product	Mix Ratio	Coverage Rate	Mils WFT/DFT	Recoat Time at 75° F/23° C
Primer	7740/7741	2:1	200 sf/gal	NA	5 hours
Base Coat	7825/7821	3:1	66 sf/gal	24 WFT/24 DFT	10 hours
Topcoat	7825/7821	3:1	66 sf/gal	24 WFT/24 DFT	10 hours
Exterior Finish Primer	Ureprime HS4	4:1	300 sf/gal	NA	4 hours
First Exterior Finish Coat	Acrylithane HS2	3:1	200 sf/gal	8 WFT/5 DFT	6 hours
	Acrylithane HS4	4:1	200 sf/gal	8 WFT/4 DFT	6 hours
Second Exterior Finish Coat	Acrylithane HS2	3:1	200 sf/gal	8 WFT/5 DFT	6 hours
	Acrylithane HS4	4:1	200 sf/gal	8 WFT/4 DFT	6 hours

Peda-Gard SC

Materials

- Primer: 7740/7741 (252JB).
- Base Coat: 7430 (57040) series polyurethane coating.
- Wear Coat: 7430 series (57040) polyurethane coating.
- Aggregate: 86364 (66030) silica quartz sand flooring aggregate .
- Topcoat: 7430 series (57040) polyurethane.
- CRU Finish: 70805/7952 (57020) chemical resistant urethane.

Average Dry Film Thickness

- 42 dry mils (excluding primer and aggregate).

Application Instructions

1. Primer: Thoroughly mix and apply 7740/7741 at a rate of 300 sf/gal (0.33 gal/100 sf) to all concrete surfaces in strict accordance with procedures outlined by Neogard. Within 24 hours of application of primer, base coat must be applied. If base coat cannot be applied within 24 hours, re-prime.
2. Base Coat: Thoroughly mix and apply 7430 series at a rate of 60 sf/gal (1.66 gal/100 sf or 26 wet mils) to yield 20 dry mils. Extend base coat over cracks and control joints which have received treatment.
3. Wear Coat: Thoroughly mix and apply 7430 series at a rate of 200 sf/gal (0.5 gal/100 sf or 8 wet mils), to yield 6 dry mils and immediately broadcast aggregate, evenly distributed, into wet coating at the rate of 15 pounds per 100 square feet. When dry, remove excess aggregate.

4. Topcoat: Thoroughly mix and apply 7430 series at a rate of 150 sf/gal (0.66 gal/100 sf or 10 wet mils) to yield 8 dry mils.
5. CRU Finish: Thoroughly mix and apply two coats of 70805/7952 CRU at the rate of 250 sf/gal (0.4 gal/100 sf or 6 wet mils) per coat, for a total of 8 dry mils.

Summary Application Table

Coat	Product	Mix Ratio	Coverage Rate	Mils WFT/DFT	Recoat Time at 75°F/23°C
Primer	7740/7741	2:1	300 sf/gal	NA	5 hours
Base Coat	7430 series	NA	60 sf/gal	26 WFT/20 DFT	14 hours
Wear Coat	7430 series	NA	200 sf/gal	8 WFT/6 DFT	12 hours
Topcoat	7430 series	NA	150 sf/gal	10 WFT/8DFT	12 hours
CRU Finish (2 coats)	70805/7952	2:1	250 sf/gal	12 WFT/8 DFT	NA

Perma-Gard III

Materials

- Primer: Concrete and metal primers as required by Neogard.
- Vertical Additive: 7922 (990JB) to enhance sag resistant properties of cold fluid-applied membrane waterproofing material.
- Cold Fluid-Applied Membrane: 7401 (47KJB) polyurethane.

Average Dry Film Thickness

- 60 dry mils

Application Instructions

1. Cold Fluid-Applied Membrane: Thoroughly mix 7401 waterproofing material and apply at the rate of 23 sf/gal (4.25 gal/100 sf or 68 wet mils total thickness) in a minimum of two coats to yield 60 dry mils

Note: For vertical applications, add 7922 Vertical Additive at the rate of 8 ounces per 5 gallons of membrane waterproofing material. After mixing, an induction time of 30 minutes is required to achieve a sag resistance of 16–18 mils.

1. Flood Test For Horizontal Applications: Follow ASTM D5957 standard guide for flood testing horizontal waterproofing installations.
 - A. Waterproofed area shall be flood tested for 48 hours, after system has cured 24 hours at 75°F/23°C and 50% relative prior to installation of protection course.
 - B. Plug drains on deck surface and use sand bags or other means to contain water.
 - C. Flood test to a depth of 2 inches for the duration of the test.
 - D. Repair any leaks that may appear.
2. Protection Course: Apply horizontal and/or vertical protection course in accordance with procedures recommended by protection course manufacturer.

Summary Application Table

Coat	Product	Mix Ratio	Coverage Rate	Mils WFT/DFT	Recoat Time at 75°F (23°C)
Cold Fluid-Applied Membrane	7401	NA	23 sf/gal	68 WFT/60 DFT	N/A

RTS Vehicular

Materials

- Initiator: 600 RTS PMMA/PUMA Initiator (95UJB).
- Primer: 100 RTS Concrete and Metal Primer (256JB).
- Membrane: 200 RTS Membrane PUMA coating (870JB).
- Body Coat: 300 RTS Flexible Body Coat PMMA coating (871JB).
- Topcoat: 400 RTS Topcoat PMMA coating (872JB).
- Filler: 900 RTS PMMA Filler (63ZJB).
- Aggregate: 7992 16/30 mesh silica quartz sand (66010).

Average Dry Film Thickness

- Garage, Turn Areas, Ramps, Drive Lanes System: 135 dry mils (excluding primer and aggregate)
- Extreme Service System: 175 dry mils (excluding primer and aggregate)

Application Instructions

Important: All fluid-applied RTS materials must be mixed with Neogard 600 RTS BPO Initiator before applying. Refer to the RTS BPO Initiator Dosage Chart in the Support Information section of this Application Manual for the correct amounts.

Garage, Turn Areas, Ramps, Drive Lanes System

1. Primer: Apply 100 RTS at a rate of 90 sf/gal to yield 17 mils to all surfaces. Allow to dry approximately 45 minutes.
2. Membrane: Apply 200 RTS at a rate of 26 sf/gal to yield 60 dry mils. Extend base coat over cracks and control joints which have received detail treatment.
3. Flexible Body Coat: Mix 300 RTS with 900 RTS Filler at 10 lbs/gallon. Apply mixture at a rate of 32 sf/gal to yield 50 dry mils. Immediately broadcast aggregate, evenly distributed, to refusal into wet coating. When dry, remove excess aggregate.
4. Topcoat: Mix 400 RTS with 700 RTS series pigment at 0.25 lbs/gallon. Apply mixture at a rate of 64 sf/gal to yield 25 dry mils. Note: Light colors may require 2 coats; system mockup will determine required coverage.
5. System may be opened to traffic 1 hour after application.

Summary Application Table

Coat	Product	Mix Ratio	Coverage Rate	Dry Film Thickness	Recoat Time at 75°F/23°C
Primer	100 RTS	See BPO Chart	90 sf/gal	17 mils	When dry
Membrane	200 RTS	See BPO Chart	26 sf/gal	60 mils	When dry
Flexible Body Aggregate	300 RTS + 900 RTS 7992	See BPO Chart; 10 lbs 900 RTS/gal 300 RTS	32 sf/gal <i>To Refusal</i>	50 mils	When dry
Topcoat	400 RTS	See BPO Chart	64 sf/gal	25 mils	NA

Extreme Service System

1. Primer: Apply 100 RTS at a rate of 90 sf/gal to yield 17 mils to all surfaces. Allow to dry approximately 45 minutes.
2. Membrane: Apply 200 RTS at a rate of 26 sf/gal to yield 60 dry mils. Extend base coat over cracks and control joints which have received detail treatment.
3. Flexible Body Coat: Mix 300 RTS with 900 RTS Filler at 10 lbs/gallon. Apply mixture at a rate of 18 sf/gal to yield 90 dry mils. Immediately broadcast aggregate, evenly distributed, to refusal into wet coating. When dry, remove excess aggregate
4. Topcoat: Mix 400 RTS with 700 RTS series pigment at 0.25 lbs/gallon. Apply mixture at a rate of 64 sf/gal to yield 25 dry mils. Note: Light colors may require 2 coats; system mockup will determine required coverage.
5. System may be opened to traffic 1 hour after application.

Summary Application Table

Coat	Product	Mix Ratio	Coverage Rate	Dry Film Thickness	Recoat Time at 75°F/23°C
Primer	100 RTS	See BPO Chart	90 sf/gal	17 mils	When dry
Membrane	200 RTS	See BPO Chart	26 sf/gal	60 mils	When dry
Flexible Body Aggregate	300 RTS + 900 RTS 7992	See BPO Chart; 10 lbs 900 RTS/gal 300 RTS	18 sf/gal <i>To Refusal</i>	90 mils	When dry
Topcoat	400 RTS	See BPO Chart	64 sf/gal	25 mils	NA

RTS Pedestrian

Materials

- Initiator: 600 RTS PMMA/PUMA Initiator (95UJB).
- Primer: 100 RTS Concrete and Metal Primer (256JB).
- Membrane: 200 RTS Membrane PUMA coating (870JB).
- Body Coat: 300 RTS Flexible Body Coat PMMA coating (871JB).
- Topcoat: 400 RTS Topcoat PMMA coating (872JB), with pigment.
- Filler: 900 RTS PMMA Filler (63ZJB).
- Aggregate: 86364 20/40 mesh silica quartz sand (66030).

Average Dry Film Thickness

- System A: 102 dry mils (excluding primer and aggregate)
- System B: 85 dry mils (excluding primer and aggregate)

Application Instructions

Important: All fluid-applied RTS materials must be mixed with Neogard 600 RTS BPO Initiator before applying. Refer to the RTS BPO Initiator Dosage Chart in the Support Information section of this Application Manual for the correct amounts.

(continued on next page)

System A

1. Primer: Apply primer at a rate of 90 sf/gal to yield 17 mils to all surfaces. Allow to dry approximately 45 minutes.
2. Membrane: Mix 200 RTS Membrane with 700 RTS series pigment (for added visibility) at 0.25 lbs/gallon. Apply at a rate of 26 sf/gal to yield 60 dry mils. Extend base coat over cracks and control joints which have received detail treatment.
3. Flexible Body Coat: Apply 300 RTS Flexible Body Coat at a rate of 90 sf/gal to yield 17 dry mils. Immediately broadcast 20/40 mesh silica quartz aggregate to excess. When dry, remove excess aggregate.
4. Topcoat: Mix 400 RTS with 700 RTS series pigment at 0.25 lbs/gallon. Apply mixture at a rate of 64 sf/gal to yield 25 dry mils. Note: Light colors may require 2 coats; system mockup will determine required coverage.
5. System may be opened to traffic 1 hour after application.

Summary Application Table

Coat	Product	Mix Ratio	Coverage Rate	Dry Film Thickness	Recoat Time at 75°F/23°C
Primer	100 RTS	See BPO Chart	90 sf/gal	17 mils	When dry
Membrane	200 RTS	See BPO Chart	26 sf/gal	60 mils	When dry
Flexible Body Aggregate	300 RTS 86364	See BPO Chart	90 sf/gal To Refusal	17 mils	When dry
Topcoat	400 RTS	See BPO Chart	64 sf/gal	25 mils	NA

System B

1. Primer: Apply 100 RTS at a rate of 90 sf/gal to yield 17 mils to all surfaces. Allow to dry approximately 45 minutes.
2. Flexible Body Coat: Mix 300 RTS with 900 RTS Filler at 10 lbs/gal. Apply mixture at a rate of 26 sf/gal to yield 60 dry mils. Immediately broadcast 86364 aggregate to excess. When dry, remove excess aggregate.
3. Topcoat: Mix 400 RTS with 700 RTS series pigment at 0.25 lbs/gallon. Apply mixture at a rate of 64 sf/gal to yield 25 dry mils. Note: Light colors may require 2 coats; system mockup will determine required coverage.
4. System may be opened to traffic 1 hour after application.

Summary Application Table

Coat	Product	Mix Ratio	Coverage Rate	Dry Film Thickness	Recoat Time at 75°F/23°C
Primer	100 RTS	See BPO Chart	90 sf/gal	17 mils	When dry
Flexible Body Aggregate	300 RTS + 900 RTS 7992	See BPO Chart; 10 lbs 900 RTS/gal 300 RTS	26 sf/gal To Refusal	60 mils	When dry
Topcoat	400 RTS	See BPO Chart	64 sf/gal	25 mils	NA

RTS Decorative Flake

Materials

- Initiator: 600 RTS PMMA/PUMA Initiator (95UJB).
- Primer: 100 RTS Concrete and Metal Primer (256JB).
- Membrane: 200 RTS Membrane PUMA coating (870JB).
- Body Coat: 300 RTS Flexible Body Coat PMMA coating (871JB).
- Topcoat: 400 RTS Topcoat PMMA coating (872JB).
- Filler: 900 RTS PMMA Filler (63ZJB).
- Aggregate: UV-stable flakes (contact Neogard for source).

Average Dry Film Thickness

- System A: 97–102 dry mils (excluding primer and aggregate)
- System B: 130–135 dry mils (excluding primer and aggregate)

Application Instructions

Important: All fluid-applied RTS materials must be mixed with Neogard 600 RTS BPO Initiator before applying. Refer to the RTS BPO Initiator Dosage Chart in the Support Information section of this Application Manual for the correct amounts.

System A

1. Primer: Apply 100 RTS Concrete and Metal Primer at a rate of 90 sf/gal to yield 17 mils to all surfaces. Allow to dry approximately 45 minutes.
2. Membrane: Mix 200 RTS Membrane with 700 RTS series pigment at 0.25 lbs/gallon. Apply at a rate of 26 sf/gal to yield 60 dry mils.
3. Flexible Body Coat: Apply 300 RTS Flexible Body Coat mixed with 900 RTS Filler at 10 lbs/gal and apply at a rate of 80 sf/gal to yield 20 dry mils and immediately broadcast flakes into wet coating until refusal (approximately 25 lbs/100 sf). When dry, remove excess flakes and lightly abrade flake surface with palm sander utilizing 80 grit sand paper or use a Bully Tool® Pro Grade Floor Scraper or similar tool. Remove debris.
4. Topcoat: Mix and apply 400 RTS Topcoat at a rate of 64–80 sf/gal to yield 25–20 dry mils.
5. System may be opened to traffic 1 hour after application.

Summary Application Table

Coat	Product	Mix Ratio	Coverage Rate	Dry Film Thickness	Recoat Time at 75° F/23° C
Primer	100 RTS	See BPO Chart	90 sf/gal	17 mils	When dry
Membrane	200 RTS + RTS 700 pigment	See BPO Chart	26 sf/gal	60 mils	When dry
Flexible Body Aggregate	300 RTS + 900 RTS <i>UV-stable flakes</i>	See BPO Chart; 10 lbs 900 RTS/ gal 300 RTS	80 sf/gal <i>To Refusal</i>	20 mils	When dry
Topcoat	400 RTS	See BPO Chart	80–64 sf/gal	20–25 mils	NA

(continued on next page)

System B

1. Primer: Apply 100 RTS Concrete and Metal Primer at a rate of 90 sf/gal to yield 17 mils to all surfaces. Allow to dry approximately 45 minutes.
2. Flexible Body Coat: Apply 300 RTS Flexible Body Coat mixed with 900 RTS Filler at 10 lbs/gal at a rate of 26 sf/gal to yield 60 dry mils and immediately broadcast flakes into wet coating until refusal (approximately 25 lbs/100 sf). When dry, remove excess flakes and lightly abrade flake surface with palm sander utilizing 80 grit sand paper or use a Bully Tool® Pro Grade Floor Scraper or similar tool. Remove debris.
3. Topcoat: Mix and apply 400 RTS Topcoat at a rate of 64–80 sf/gal to yield 25–20 dry mils.

Summary Application Table

Coat	Product	Mix Ratio	Coverage Rate	Dry Film Thickness	Recoat Time at 75°F/23°C
Primer	100 RTS	See BPO Chart	90 sf/gal	17 mils	When dry
Flexible Body Aggregate	300 RTS + 900 RTS <i>UV-stable quartz</i>	See BPO Chart; 10 lbs 900 RTS/gal 300 RTS	26 sf/gal <i>To Refusal</i>	60 mils	When dry
Topcoat	400 RTS	See BPO Chart	64–80 sf/gal	20–25 mils	NA

RTS Decorative Quartz

Materials

- Initiator: 600 RTS PMMA/PUMA Initiator (95UJB).
- Primer: 100 RTS Concrete and Metal Primer (256JB).
- Membrane: 200 RTS Membrane PUMA coating (870JB).
- Body Coat: 300 RTS Flexible Body Coat PMMA coating (871JB).
- Topcoat: 400 RTS Topcoat PMMA coating (872JB).
- Filler: 900 RTS PMMA Filler (63ZJB).
- Aggregate: Choose one; contact Neogard for available colors.
 - Estes Permacolor HP Quartz Granules, UV stable, Medium (20/70 mesh).
 - Trowel-Rite® (20/40 mesh) inorganic UV stable quartz aggregate.

Average Dry Film Thickness

- System A: 97–102 dry mils (excluding primer and aggregate)
- System B: 130–135 dry mils (excluding primer and aggregate)

Application Instructions

Important: All fluid-applied RTS materials must be mixed with Neogard 600 RTS BPO Initiator before applying. Refer to the RTS BPO Initiator Dosage Chart in the Support Information section of this Application Manual for the correct amounts.

System A

1. Primer: Apply 100 RTS at a rate of 90 sf/gal to yield 17 mils to all surfaces. Allow to dry approximately 45 minutes.

2. Membrane: Apply 200 RTS at a rate of 26 sf/gal to yield 60 dry mils.
3. Flexible Body Coat: Apply 300 RTS Flexible Body Coat at a rate of 94 sf/gal to yield 17 dry mils. Immediately broadcast UV stable quartz aggregate, evenly distributed, to refusal into wet coating. When dry, remove excess aggregate.
4. Topcoat: Apply 400 RTS Topcoat at a rate of 64–80 sf/gal to yield 25–20 dry mils
5. System may be opened to traffic 1 hour after application.

Summary Application Table

Coat	Product	Mix Ratio	Coverage Rate	Dry Film Thickness	Recoat Time at 75°F/23°C
Primer	100 RTS	See BPO Chart	90 sf/gal	17 mils	When dry
Membrane	200 RTS	See BPO Chart	26 sf/gal	60 mils	When dry
Flexible Body Aggregate	300 RTS <i>UV-stable quartz</i>	See BPO Chart	94 sf/gal <i>To Refusal</i>	17 mils	When dry
Topcoat	400 RTS	See BPO Chart	64–80 sf/gal	20–25 mils	NA

System B

1. Primer: Apply 100 RTS at a rate of 90 sf/gal to yield 17 mils to all surfaces. Allow to dry approximately 45 minutes.
2. Membrane: Apply 200 RTS at a rate of 26 sf/gal to yield 60 dry mils.
3. Flexible Body Coat: Apply 300 RTS Flexible Body Coat mixed with 900 RTS Filler at 10 lbs/gal at a rate of 26 sf/gal to yield 60 dry mils. Immediately broadcast decorative quartz aggregate, evenly distributed, to refusal into wet coating. When dry, remove excess aggregate.
4. Topcoat: Apply 400 RTS Topcoat at a rate of 64–80 sf/gal to yield 25–20 dry mils
5. System may be opened to traffic 1 hour after application.

Summary Application Table

Coat	Product	Mix Ratio	Coverage Rate	Dry Film Thickness	Recoat Time at 75°F/23°C
Primer	100 RTS	See BPO Chart	90 sf/gal	17 mils	When dry
Membrane	200 RTS	See BPO Chart	26 sf/gal	60 mils	When dry
Flexible Body Aggregate	300 RTS + 900 RTS <i>UV-stable quartz</i>	See BPO Chart; 10 lbs 900 RTS/gal 300 RTS	26 sf/gal <i>To Refusal</i>	50 mils	When dry
Topcoat	400 RTS	See BPO Chart	64–80 sf/gal	20–25 mils	NA

RTS Helipad

Materials

- Initiator: 600 RTS PMMA/PUMA Initiator (95UJB).
- Primer: 100 RTS Concrete and Metal Primer (256JB).
- Membrane: 200 RTS Membrane PUMA coating (870JB).
- Body Coat: 300 RTS Flexible Body Coat PMMA coating (871JB).

(continued on next page)

- Topcoat: 400 RTS Topcoat PMMA coating (872JB).
- Filler: 900 RTS PMMA Filler (63ZJB).
- Aggregate: #16 aluminum oxide (contact Neogard for approved source).

Average Dry Film Thickness

- 150–175 dry mils (excluding primer and aggregate)

Application Instructions

Important: All fluid-applied RTS materials must be mixed with Neogard 600 RTS BPO Initiator before applying. Refer to the RTS BPO Initiator Dosage Chart in the Support Information section of this Application Manual for the correct amounts.

1. Primer: Apply 100 RTS at a rate of 90 sf/gal to yield 17 mils to all surfaces. Allow to dry approximately 45 minutes.
2. Membrane: Apply 200 RTS at a rate of 26 sf/gal to yield 60 dry mils. Extend base coat over cracks and control joints which have received detail treatment.
3. Flexible Body Coat: Mix 300 RTS with 900 RTS PMMA Filler at 10 lbs/gallon. Apply mixture at a rate of 25 sf/gal to yield 65 dry mils. Immediately broadcast aggregate, evenly distributed, to refusal into wet coating. When dry, remove excess aggregate.
4. Topcoat: Mix 400 RTS with 700 RTS series pigment at 0.25 lbs/gallon. Apply mixture at a rate of 64 sf/gal to yield 25 dry mils. Note: Light colors may require 2 coats; system mockup will determine required coverage.
5. Markings: Mix 400 RTS with pigment at 0.25 lbs/gallon. Apply mixture at a rate of 64 sf/gal to yield 25 dry mils.
6. System may be opened to traffic 1 hour after application.

Summary Application Table

Coat	Product	Mix Ratio	Coverage Rate	Dry Film Thickness	Recoat Time at 75°F/23°C
Primer	100 RTS	See BPO Chart	90 sf/gal	17 mils	When dry
Membrane	200 RTS	See BPO Chart	26 sf/gal	60 mils	When dry
Flexible Body Aggregate	300 RTS + 900 RTS #16 aluminum oxide	See BPO Chart; 10 lbs 900 RTS/gal 300 RTS	25 sf/gal <i>To Refusal</i>	65 mils	When dry
Topcoat	400 RTS	See BPO Chart	64 sf/gal	25 mils	NA
Markings	400 RTS	See BPO Chart	64 sf/gal	25 mils	NA

RTS Under Tile

Materials

- Initiator: 600 RTS PMMA/PUMA Initiator (95UJB).
- Primer: 100 RTS Concrete and Metal Primer (256JB).
- Membrane: 200 RTS Membrane PUMA coating (870JB).
- Body Coat: 300 RTS Flexible Body Coat PMMA coating (871JB).
- Aggregate: 7992 16/30 mesh silica quartz (990JB).

Average Dry Film Thickness

- 80 dry mils (excluding primer and aggregate)

Application Instructions

Important: All fluid-applied RTS materials must be mixed with Neogard 600 RTS BPO Initiator before applying. Refer to the RTS BPO Initiator Dosage Chart in the Support Information section of this Application Manual for the correct amounts.

1. Primer: Apply 100 RTS at a rate of 90 sf/gal to yield 17 mils to all surfaces. Allow to dry approximately 45 minutes.
2. Membrane Coat: Apply 200 Membrane at a rate of 26 sf/gal to yield 60 dry mils,
3. Flexible Body Coat: Apply 300 Flexible Body Coat at a rate of 80 sf/gal to yield 20 dry mils. Immediately broadcast aggregate to refusal. When dry, remove excess aggregate.
4. System may be opened to traffic 1 hour after application.

Summary Application Table

Coat	Product	Mix Ratio	Coverage Rate	Dry Film Thickness	Recoat Time at 75°F/23°C
Primer	100 RTS	See BPO Chart	90 sf/gal	17 mils	When dry
Membrane	200 RTS	See BPO Chart	26 sf/gal	60 mils	When dry
Flexible Body Aggregate	300 RTS 7992	See BPO Chart	80 sf/gal <i>To Refusal</i>	20 mils	When dry

RTS Buried Horizontal Waterproofing

Materials

- Initiator: 600 RTS PMMA/PUMA Initiator (95UJB).
- Primer: 100 RTS Concrete and Metal Primer (256JB).
- Membrane: 200 RTS Membrane PUMA coating (870JB).
- Protection Board/Overburden (contact Neogard for approved source).

Average Dry Film Thickness

- 80 dry mils (excluding primer and aggregate)

Application Instructions

Important: All fluid-applied RTS materials must be mixed with Neogard 600 RTS BPO Initiator before applying. Refer to the RTS BPO Initiator Dosage Chart in the Support Information section of this Application Manual for the correct amounts.

1. Primer: Apply 100 RTS at a rate of 90 sf/gal to yield 17 mils to all surfaces. Allow to dry approximately 45 minutes.
2. Membrane: Apply 200 RTS Membrane at a rate of 20–13 sf/gal to yield 80–120 dry mils.
3. Allow to cure for one hour before covering.

(continued on next page)

Summary Application Table

Coat	Product	Mix Ratio	Coverage Rate	Dry Film Thickness	Recoat Time at 75°F/23°C
Primer	100 RTS	See BPO Chart	90 sf/gal	17 mils	When dry
Membrane	200 RTS	See BPO Chart	20–13 sf/gal	80–120 mils	When dry

Detail Drawings

Introduction

The following details are utilized in the specification and design of Neogard deck coating and waterproofing systems in both new and retrofit applications. They are provided to show a generally recommended procedure for dealing with the condition shown. They will not and cannot provide a specific solution for every condition likely to be encountered in field application. Where field conditions differ, the use of applicable portions of the details shown on their adaptation by an experienced and conscientious applicator should result in a quality project. If you have specific project related questions, contact Neogard Technical Services at www.Neogard.com.

Through Slab Crack

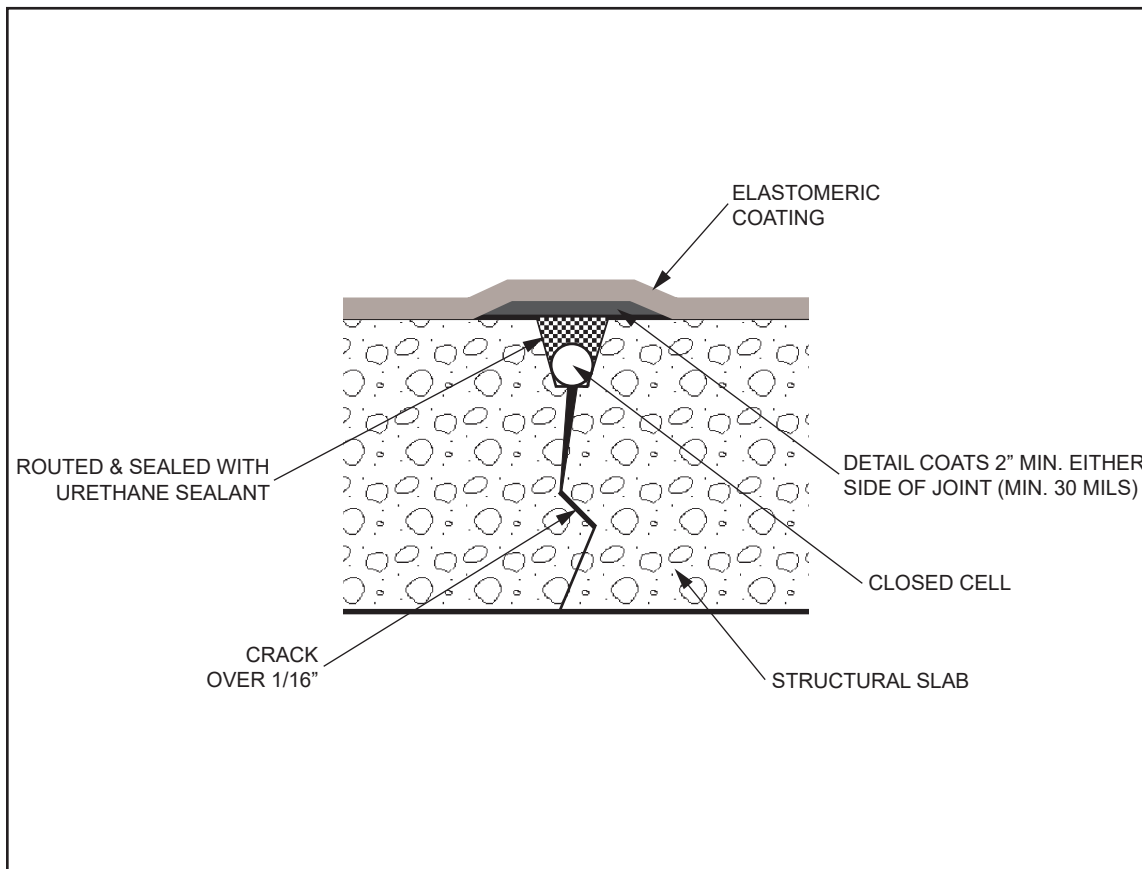

Crack Detail

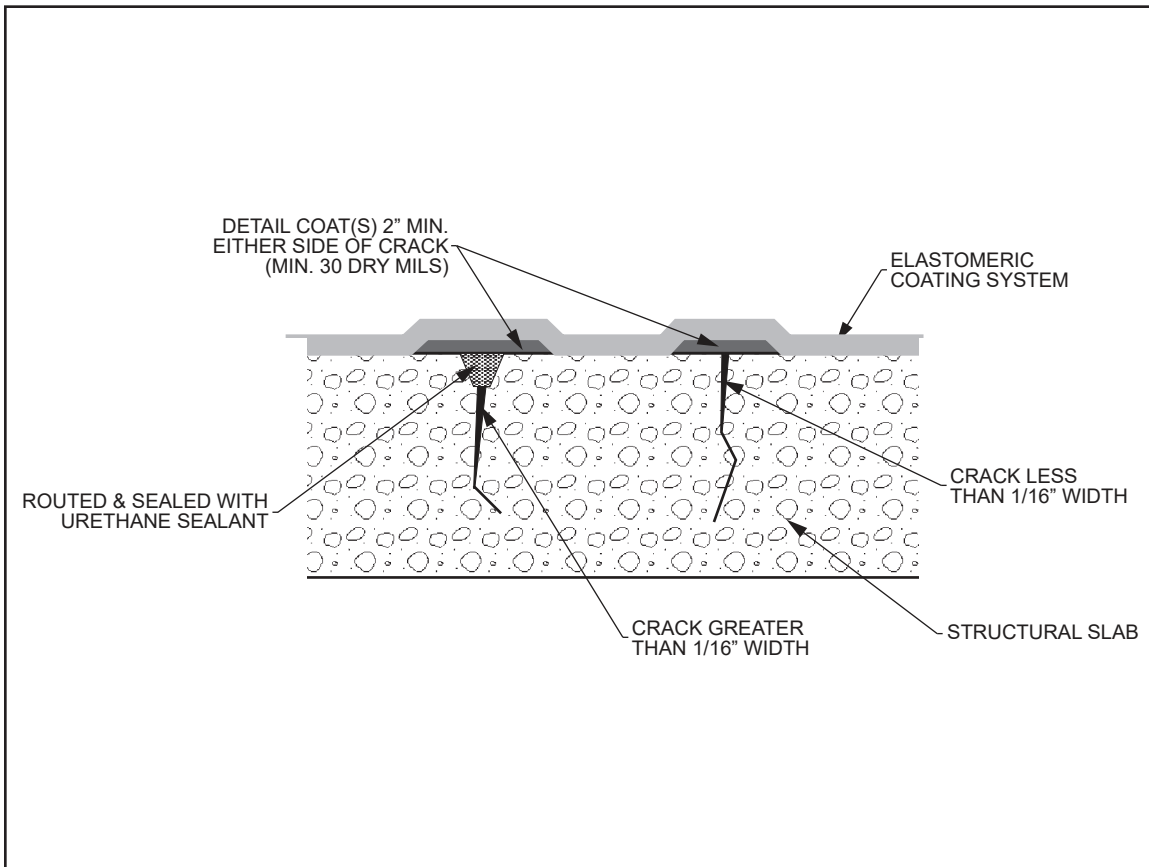

Vertical Projection

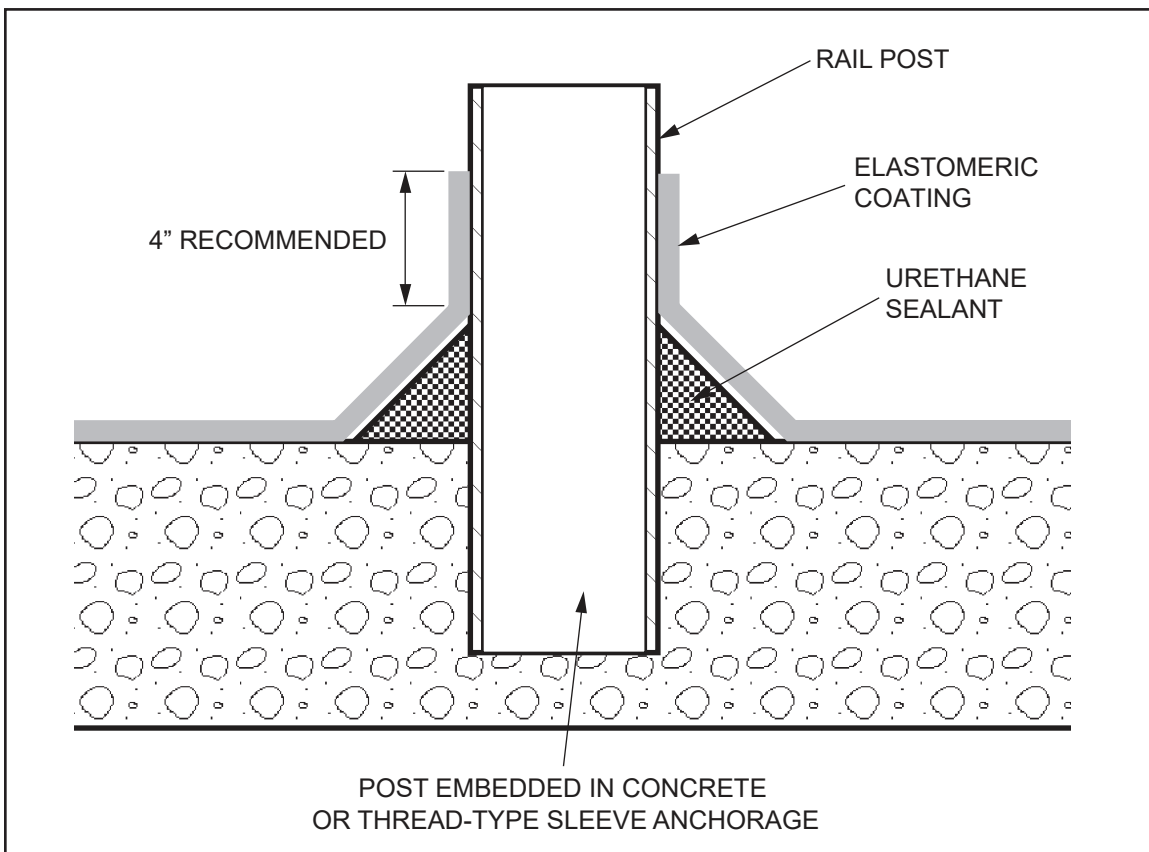

Typical Deck Flashing

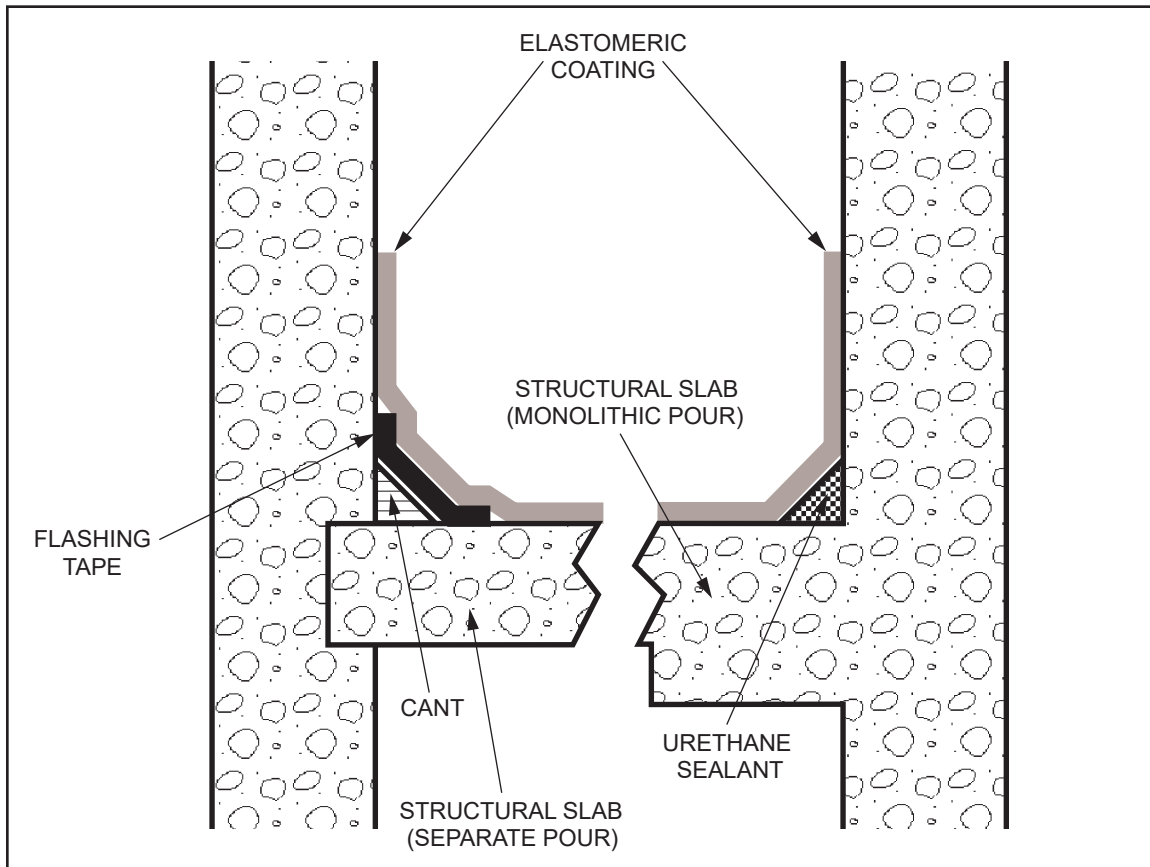

Drain Detail

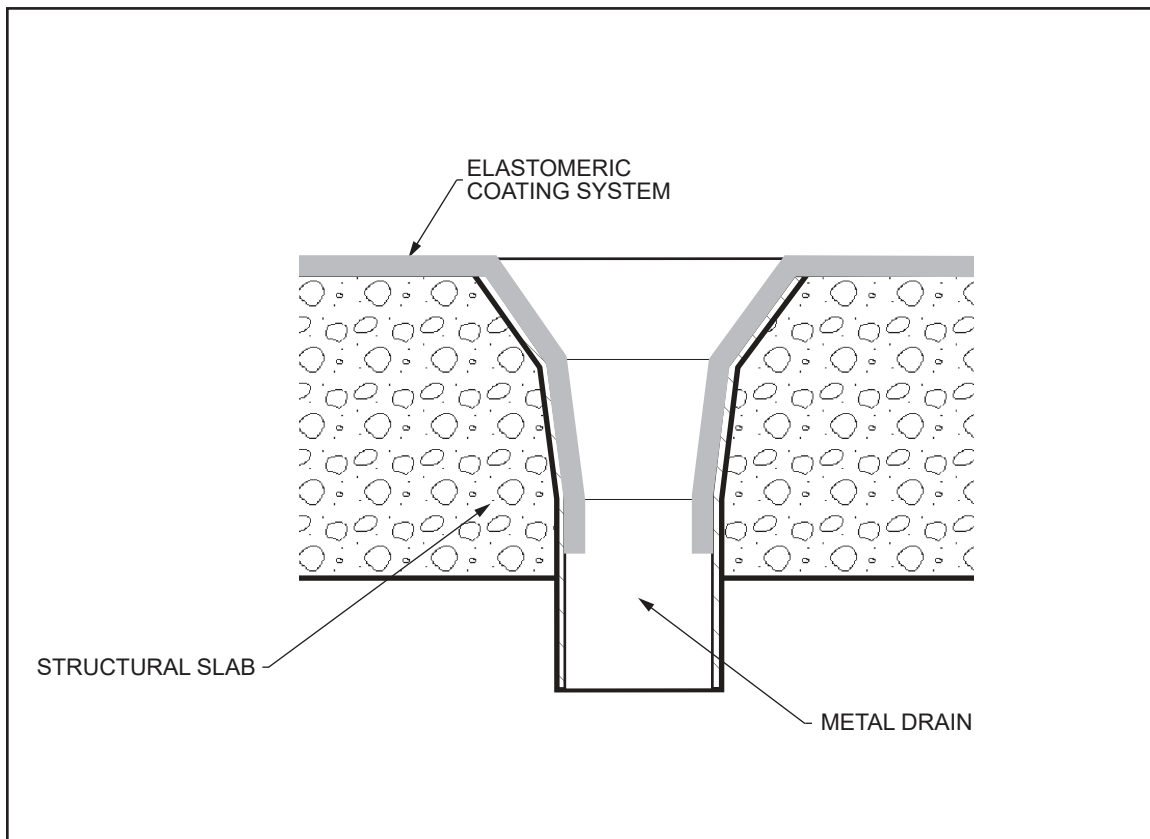

Double-Tee Crack Control

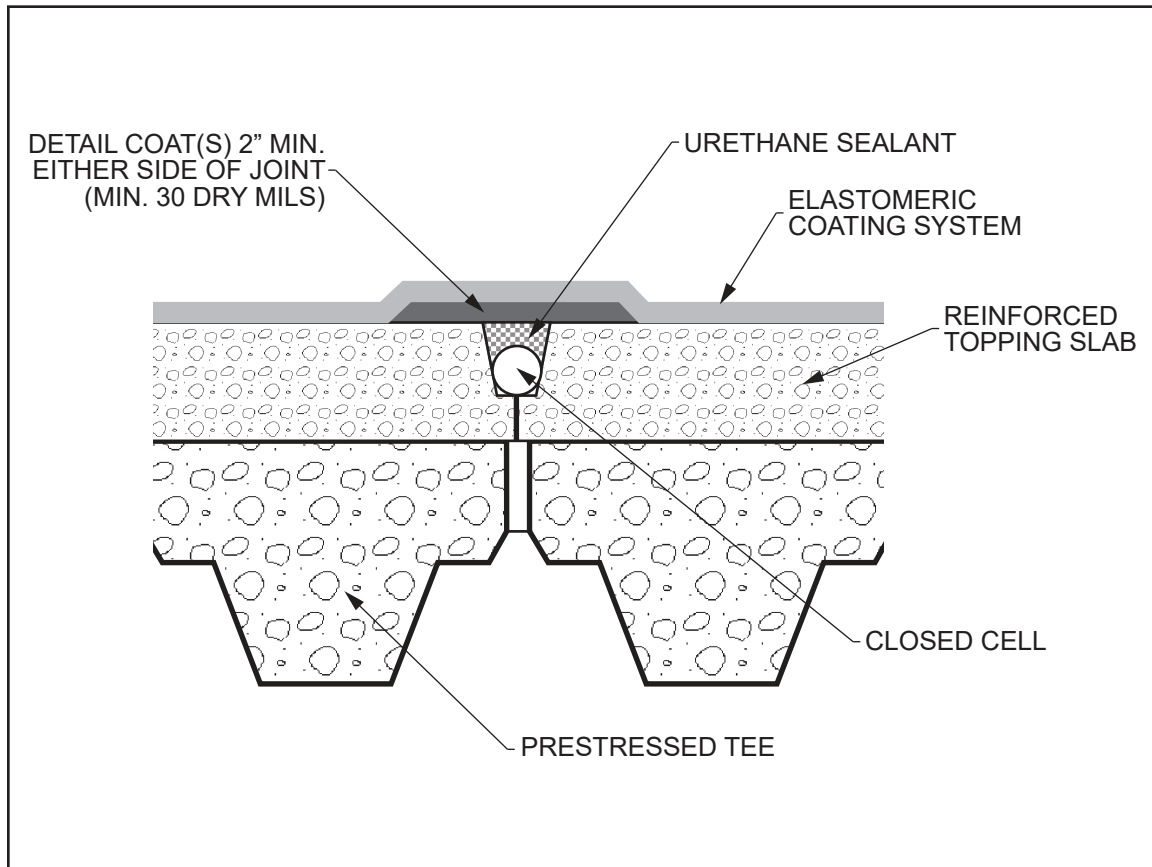

Double-Tee Joint (Option)

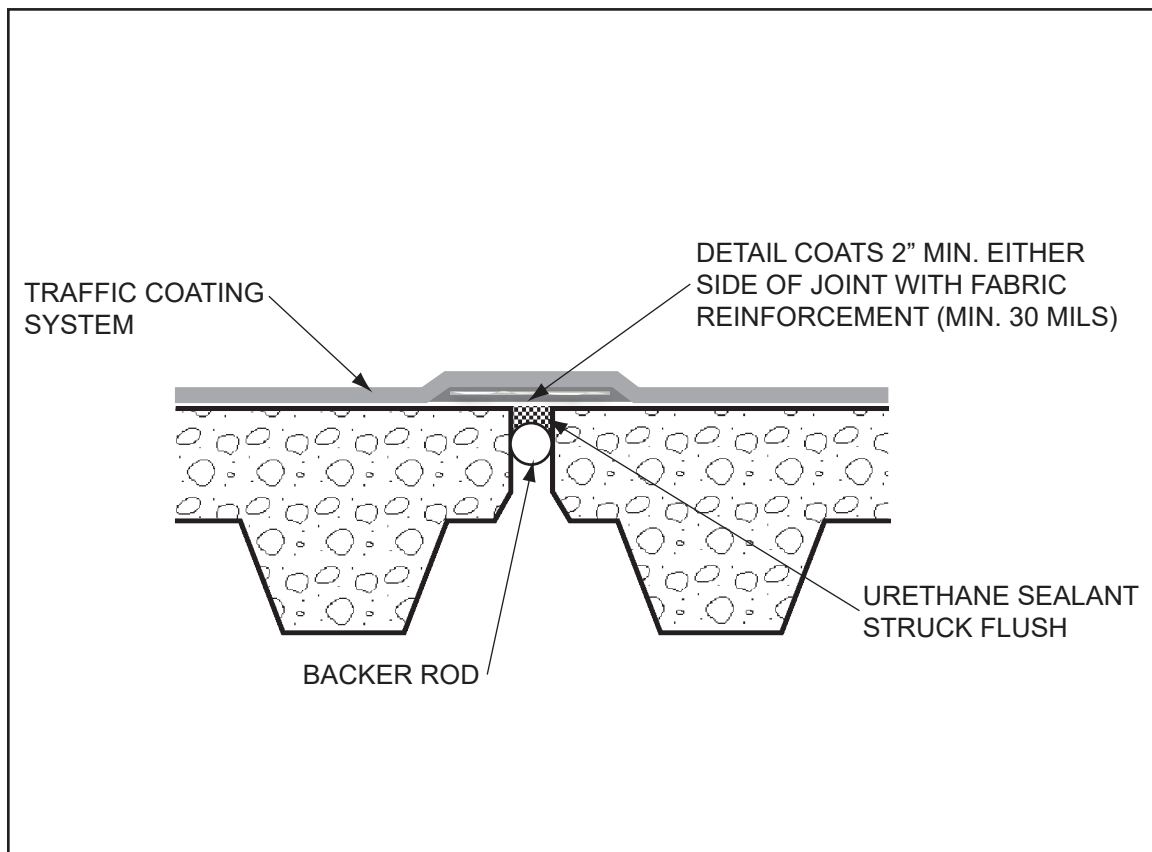

Horizontal Termination

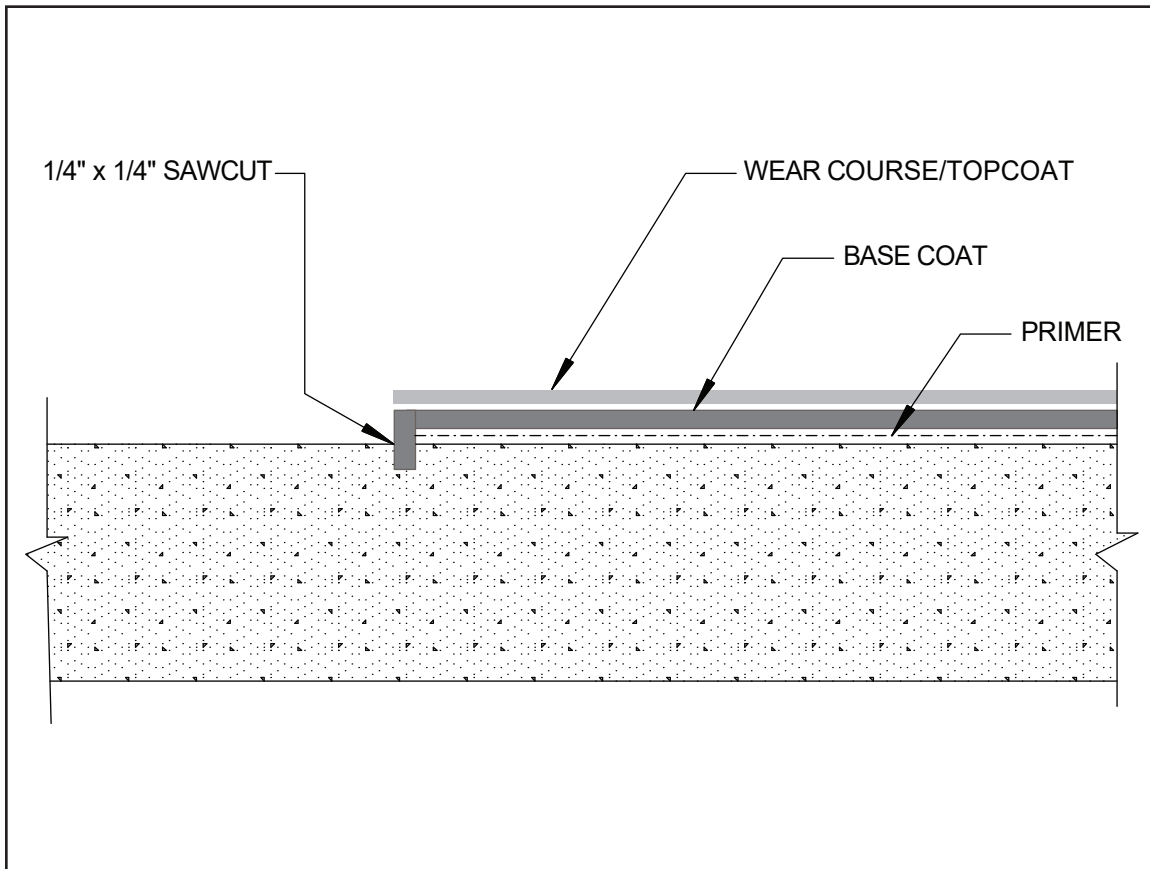

Expansion Joint

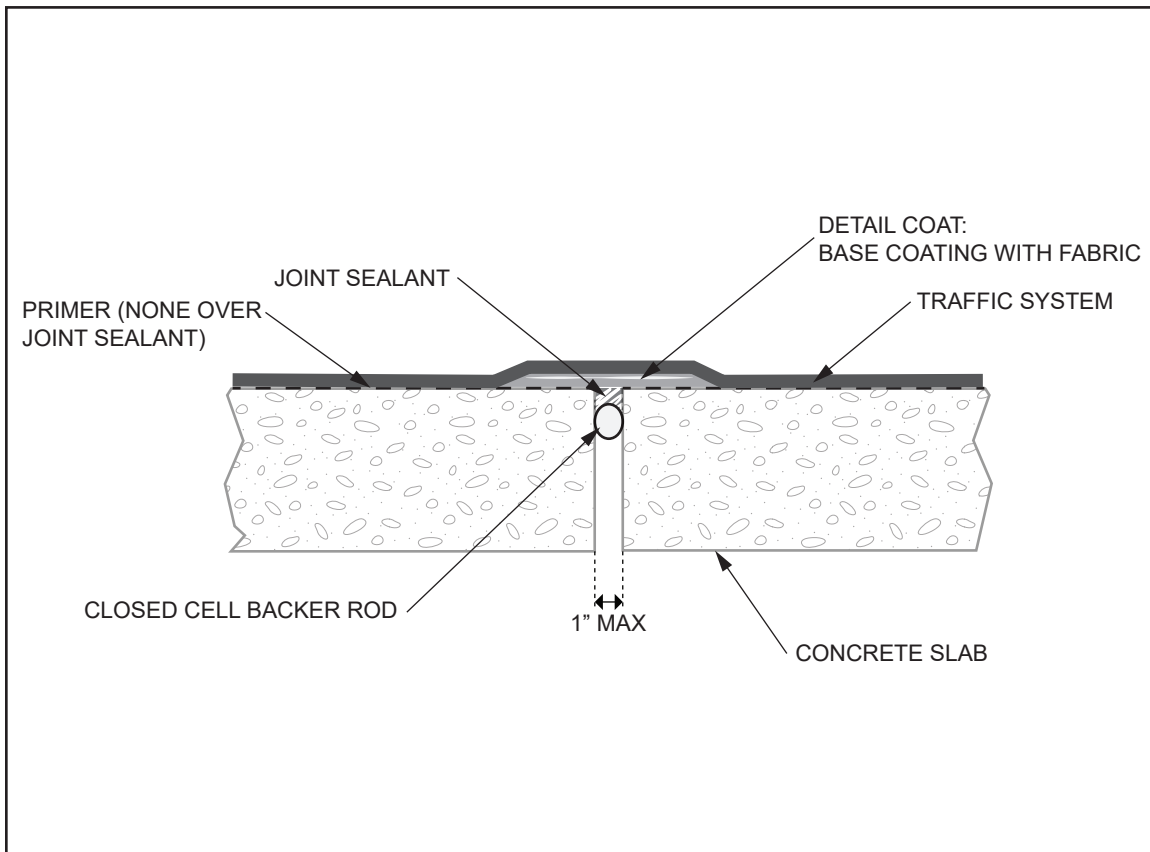

Recoat Guidelines

This section provides general information and procedures for recoating existing coating systems with Neogard fluid-applied coatings. When recoating an existing Neogard system or one from another manufacturer, performing a Field Adhesion Test is highly recommended, both with and without primer. For information on repairs or when bidding a competitive recoat specification, contact your Neogard Regional Manager for additional information.

Preparing to Recoat

Inspecting Existing Coating System, Exposed Concrete and Metal Substrates

1. Inspect existing coating system and remove all existing surface applied membrane material that is loose or marginally bonded.
2. Check exposed concrete surfaces for soundness. Detect concrete spalls in surfaces by tapping with a hammer or dragging a heavy chain and listening for a hollow sound. The hollow sound indicates problem areas. All spalled portions must be removed before further preparation. Removal can be completed with chipping hammers or other suitable tools.
3. Where concrete was removed, follow ICRI guidelines (<http://www.icri.org>) for preparation and installation of repair materials.
4. For smaller repairs such as divots, popouts, etc., Neogard 70714/70715 series epoxy mortar has many advantages:
 - Neogard 70714/70715 series epoxy is mixed with selected sand to form the mortar. In using this mortar, it is important to match the characteristics of the concrete being repaired. If a sand-to-binder ratio of approximately 4:1 or as much as 5:1 by volume is maintained, the thermal coefficient of expansion of the mix will closely approximate that of concrete. This prevents failure of the bond caused by freeze-thaw cycles or wide fluctuations in temperature. Repairs made with epoxy mortar should be no deeper than 1/2"–3/4". Large scale repairs to be made with conventional cement based repair materials/ICRI guidelines (<http://www.icri.org>).
 - Protrusions, such as fins or mortar spatter are easily removed by grinding or impact.
5. After the concrete, cementitious repair materials, or Neogard 70714/70715 series epoxy patching material has been placed and properly cured, solvent clean existing membrane perimeter adjacent to patch a minimum distance of one inch.
 - When patching concrete, new concrete patches and cementitious repair materials must be prepared by shot-blasting or a cup grinder prior to application of primer.
 - Verify dryness of concrete patches for a dry surface in accordance with ASTM D4263 "Standard Test Method for Indicating Moisture in Concrete by the Plastic Sheet Method", as outlined in the Concrete Moisture Testing section of this Application Manual.
6. All exposed metals to be coated should be mechanically prepared to a clean, white metal finish and primed with Ureprime HS4 or 7797/7798 General Purpose Primer, at a rate of 300–400 square feet/gallon.

Cleaning of Existing Coating System

1. Visually inspect deck for oil or grease deposits and remove by chemical cleaning with detergents, caustic soda solution, or trisodium phosphate. A vigorous scrubbing action should be carried out during the washing procedure. It is important to thoroughly flush the water to remove all traces of the loosened oil as well as the cleaning solution itself. If any residue remains, it will interfere with the bond of the new membrane.
2. Clean existing deck coating by power washing with 8500 BioDegradable Cleaner or other similar detergent at 600–800 psi. The use of stiff bristle brooms may be required to help remove some contaminants. Rinse deck thoroughly with clean water and allow to dry completely. All low spots where water puddles must be vacuumed dry to remove any contaminants left by the rinsing operation.
3. Visually re-inspect the deck. Repeat Steps 1 and/or 2 as needed.

Repairing Cracks and Installing Base Coat on Exposed Concrete Surfaces

1. **Materials** Inspect all surfaces for cracks and cold joints. Cold joints and visible hairline cracks (up to 1/16" in width) in existing membrane or new patching material shall be cleaned, primed (on concrete or patching material) and treated with 30 dry mils of polyurethane Base Coat material. Large cracks (over 1/16" in width) shall be routed and sealed with 70991 polyurethane sealant as recommended by Neogard. Sealant shall be applied to inside area of crack only, not applied to deck surface. After sealant has cured, detail sealed cracks with 30 dry mils of polyurethane Base Coat material.

Note: Sealant must be solvent wiped. Allow solvent to flash off prior to installation of Base Coat detail stripe and/or Base Coat application.

2. Apply Neogard primer to bare concrete or cementitious patching material. Neogard 7797/7798 General Purpose Primer or 70714/70715 series 100% epoxy is recommended for priming prior to recoat. Apply Neogard Base Coat to yield 20 dry mils. Apply 70410 solvent-based coating at a rate of 60 sf/gal (27 wet mils) OR FC7500/FC7960 Base Coat at 80 sf/gal (20 wet mils). Allow to cure.

Field Adhesion Testing

Field Adhesion Testing must be performed onsite to determine the necessity of priming over existing systems and to verify material compatibility and adhesion.

For acceptable testing methods, see the Field Adhesion Testing section of this Application Manual.

System Recoat Guidelines

The following recoat guidelines and application rates apply to recoating both existing pedestrian and vehicular coating systems.

1. As needed per the Field Adhesion Test results, apply 7797/7798 General Purpose Urethane Primer at a rate of 300 - 400 sf/gallon OR 70714/70715-09 100% solids epoxy at a rate of 200 sf/gallon to all surfaces.
2. As needed, apply Base Coat material to existing surface.
3. Apply Wear Coat and Topcoat material per standard Neogard guide specification for Vehicular or Pedestrian application.

Note: Existing 7430 systems may be recoated with 7430 and 70410 without use of primer.

Note: Existing Decorative Peda-Gard systems must be abraded using a stainless steel wire cup wheel and solvent wiped with VOC-compliant product, prior to recoat application.

Recoating FC and FC T Systems

If the topcoat has been in place four weeks or less:

1. Clean the surface
2. Solvent wipe with Neogard 7055 Odorless Reducer and allow to fully evaporate.
3. Apply the new FC or FC T topcoat at the specified coverage rate.

If the topcoat has been in place longer than four weeks:

1. Clean the surface.
2. Solvent wipe with Neogard 7055 Odorless Reducer and allow to fully evaporate.
3. Apply one of the following primers:
 - 7797/7798 urethane at at least 300 sf/gal
 - 70714/70715 epoxy at 200 sf/gal
4. When the primer is fully cured, apply the new FC or FC T topcoat at the specified coverage rate.

Field Adhesion Testing

Conduct field adhesion tests to confirm the proper procedure for recoating an existing coating system as well as system compatibility. Neogard recommends performing one of the following adhesion tests. Conduct adhesion testing in the field, as it represents actual job conditions. The following are summaries of adhesions tests. For further information please refer to ASTM standards.

ASTM D903

Standard Test Method for Peel or Stripping of Adhesive Bonds. This test is also known as the “Adhesion in Peel” or “Peel Adhesion” test and results in a quantitative value stated in lbs./linear inch or PLI.

Items Needed

- Solvent/Cleaner
- Clean Rags
- Primer (if applicable)
- Coating Material
- 4” Roller/Cover or 3” Brush
- Fabric test strips cut to 1” x 18”-24”
- Painter’s Tape
- Utility Knife
- Spring Scale/Fish Scale (calibrated to pounds and ounces)

Procedure

1. Clean and prepare substrate as required by relevant specification.
2. If applicable, apply primer and allow to cure.
3. Apply coating at 16 wet mils. Coating is applied to an area 4” X 14” minimum.
4. Work fabric strips into wet coating, allowing 6” of fabric to remain free of coating. Adhere the loose end of fabric to the substrate utilizing painter’s tape.
5. Allow coating to cure.
6. Apply topcoat to test area at 16 wet mils.
7. Allow coating to cure 7–10 days.



8. Remove painter's tape and tie a knot in the dry end of the fabric.
9. With the knife, score coating along the perimeter of the fabric.



10. Using a calibrated spring scale, hook the knot and pull back 180 degrees, parallel to the fabric.



11. Record the pounds per inch that separation occurred, making sure to divide the pounds of the pull by the width of fabric.
 - Test values of 4 to 5 pounds/inch for urethanes are acceptable for recoat situations.
 - Test values of 2 pounds/inch for acrylics are acceptable for recoat situations.

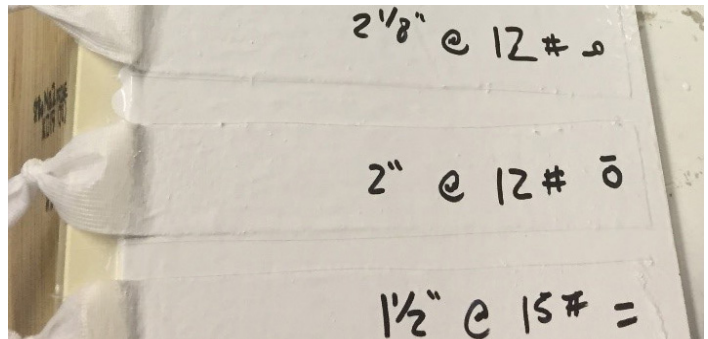

Rag Test

This test gives an indication of bond strength without numeric value. It is typically the recommended procedure for field adhesion tests. In these photos, the substrate is shown as white, primer is green and the coating is charcoal.

Items Needed

- Solvent/Cleaner
- Clean Rags
- Primer (if applicable)
- Coating
- Roller or Brush
- Polyester Fabric



Procedure

1. The substrate is prepared as required by the relevant specification.
2. If applicable, apply primer and allow to cure.
3. Apply coating with roller or brush..

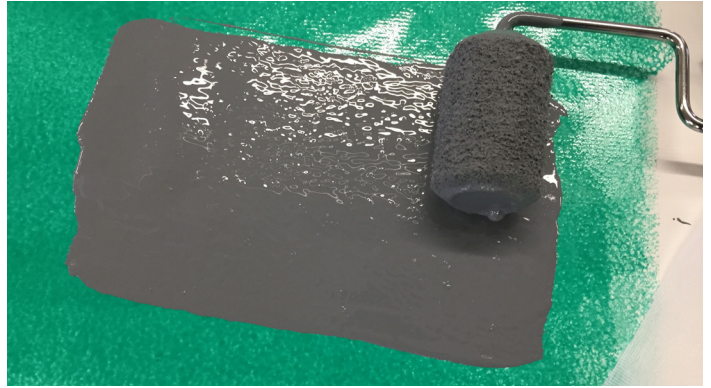

4. Work fabric into wet coating.

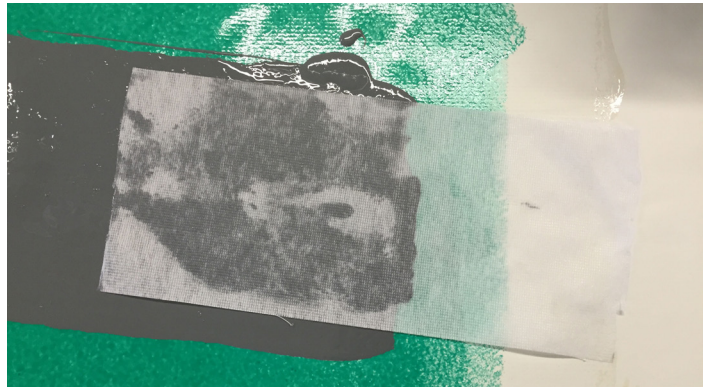

5. Apply additional coating to embed fabric, allowing a minimum of 6" in length to remain free of the coating.

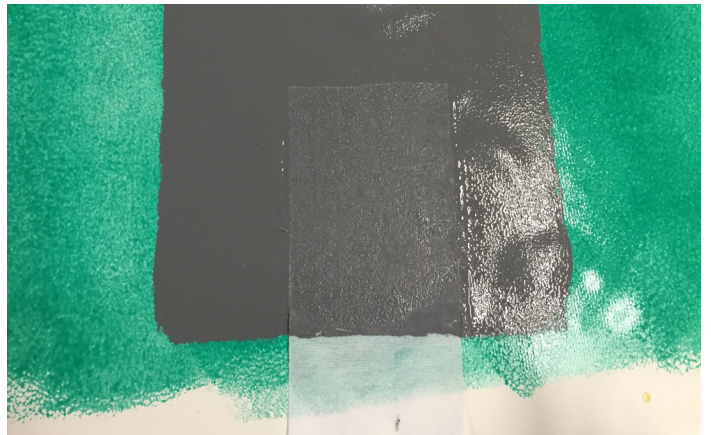

6. When coating has fully cured, generally allowing 7–10 days, pull the free end of the fabric back toward the test area for an indication of bond strength.



ASTM D7234 (Concrete Substrates)

This is a standard test method for determining pull-off strength of coatings using portable pull-off adhesion testers and was developed for concrete substrates. The following is a summary of the test procedure. For further instruction, please see the ASTM standard as well as directions provided by manufacturer of the portable pull-off adhesion tester.

Items Needed

- Solvent/Cleaner
- Clean Rags
- Utility Knife
- Adhesive
- Portable pull-off adhesion tester
- Puck (or Dolly, loading apparatus)



Procedure

1. Score through coating down to concrete substrate at a diameter equal to diameter of the puck.
2. Secure the puck to the face of the coating with an adhesive.
3. Once the adhesive has cured, attach the pull-off adhesion tester to the puck and aligned to apply tension normal to the test surface.
4. The force applied to the puck is then increased and monitored until a plug of material is detached.
 - When a plug of material is detached, the exposed surface shows the point of failure.
 - The nature of the failure is qualified according to the percent of adhesive and cohesive failures, and the interfaces and layers.
 - Pull-off adhesion strength is based on the maximum indicated load, instrument calibration data, and surface area stressed.
 - Test values above 150 psi are acceptable for new and recoat applications.



ASTM D4541 (Metal Substrates)

This is a standard test method for determining pull off strength of coatings using portable pull-off adhesion testers and was developed for metal substrates. The following is a summary of the test procedure. For further instruction, please see ASTM standard as well as directions provided by manufacturer of the portable pull-off adhesion tester.

Items Needed

- Solvent/Cleaner
- Clean Rags
- Utility Knife
- Adhesive
- Portable pull-off adhesion tester
- Puck (or Dolly, loading apparatus)



Procedure

1. Score through coating down to metal substrate at a diameter equal to diameter of the puck.
2. Secure the puck to the face of the coating with an adhesive.
3. Once the adhesive has cured, attach the pull-off adhesion tester to the puck and aligned to apply tension normal to the test surface.
4. The force applied to the puck is then increased and monitored until a plug of material is detached.
 - When a plug of material is detached, the exposed surface shows the point of failure.
 - The nature of the failure is qualified according to the percent of adhesive and cohesive failures, and the interfaces and layers.
 - Pull-off adhesion strength is based on the maximum indicated load, instrument calibration data, and surface area stressed.
 - Test values above 150 psi are acceptable for new and recoat applications.



Support Information

Coverage Rates

Theoretical vs Actual

Theoretical coverages are those calculated for glass-smooth surfaces, with no allowances made for loss. Manufacturers publish theoretical coverages instead of actual coverages because they cannot anticipate job or surface conditions. Therefore, published coverage rates should only be used as a guide for estimating material requirements for a given job.

Actual coverage will be less than theoretical coverage. When coatings are applied over concrete, many factors, such as the surface texture, overspray loss, container residue, equipment characteristics, applicator technique, etc. will directly affect the amount of coating material required to meet the designed in-place dry film thickness (DFT). Therefore, it is very important that additional material be added to the theoretical quantities to ensure that the proper coating thickness is applied. Items to consider are:

- Shot-blasted Concrete—Even though the surface texture appears to be fairly smooth, this surface can require 5%–15% additional material to the theoretical amount.
- Wind Loss—In spray applications, up to 30% of the coating may be lost due to wind. Consider using wind screens and add wind loss to your coating calculations.
- Miscellaneous Loss—A miscellaneous factor must be added to the theoretical coverage rate to cover losses due to material left in containers, equipment problems, etc. Use a percentage factor of between 3% to 10%, depending on the contractor's experience and efficiency.

Calculating Theoretical Coverage

Any liquid, when applied at a thickness of one mil (1/1000 inch) will cover 1604 square feet per gallon. Another way to state this is that one gallon of any liquid, applied over a 100 square foot surface, will be 16 mils thick when wet. To determine dry mils (or how much is left when the solvents are gone), multiply 16 (wet mils) times the solids content (by volume) of the particular liquid. Solids by weight should not be used in this formula.

Example:

- 50% solids by volume = 16 (wet mils) x 0.5 (50% solids by volume) = 8 dry mils.

To determine how much total material is required to cover 100 square feet, divide the total system thickness (expressed in mils) by the number of dry mils per gallon.

Example:

1. System = 32 dry mils total
2. Material (50% solids by volume) = 8 dry mils per gallon
3. 32 divided by 8 = 4 gallons per 100 square feet
4. % Solids by Volume X 1604 ÷ Desired Dry Mils = Coverage Rate

Calculating Actual Coverage

To determine total material requirements for a job, add estimated losses due to field conditions to theoretical coverages. Depending on jobsite conditions, up to 50% additional material may be required to meet the designed in-place dry film thickness (DFT).

Thinning and Cleaning Solvents

General Practices

Neogard products are formulated to be installed as manufactured, without thinning. However, if thinning is required, follow these practices:

- Always consult the Neogard Product Data Sheet prior to thinning the material.
- Use only Neogard manufactured or other commercial grade solvents with Neogard products.
- Be sure there is no moisture contamination in solvents, as it can produce adverse reactions.
- When thinning materials, always be aware of local VOC restrictions for coating applications before thinning.
- When thinning CA-formulated coatings, Acetone is the recommended solvent.
- Never exceed recommended thinning rates (typically no greater than 10%). Excessive thinning may affect physical properties of coating.
- Never use solvents that contain alcohol in Neogard urethane products. Alcohols react with polyurethane hardeners creating a permanent liquid state, or under-cured membrane.
- Thin and clean only with recommended products. Consult Neogard for questions regarding solvents.
- Any thinning of materials should occur after materials are mixed.

Recommended Solvents

Product Number	Material Thinning	Equipment Cleaning
7740/7741	Not Recommended	HEMPEL'S THINNER 08080 (xylene)
7760/7761	HEMPEL'S THINNER 08080 (xylene)	HEMPEL'S THINNER 08080 (xylene)
7780/7781	Not Recommended	Water
7797/7798	HEMPEL'S THINNER 08080 (xylene)	HEMPEL'S THINNER 08080 (xylene)
70714/70715	Not Recommended	HEMPEL'S THINNER 08080 (xylene)
70410	HEMPEL'S THINNER 08080 (xylene)	HEMPEL'S THINNER 08080 (xylene)
70410-CA	Acetone	Acetone
70420	HEMPEL'S THINNER 08080 (xylene)	HEMPEL'S THINNER 08080 (xylene)
70420-CA	Acetone	Acetone
7401	Do Not Thin	HEMPEL'S THINNER 08080 (xylene)
7430 series	HEMPEL'S THINNER 08080 (xylene)	HEMPEL'S THINNER 08080 (xylene)
7470 series	HEMPEL'S THINNER 08080 (xylene)	HEMPEL'S THINNER 08080 (xylene)
7475 & 7478	HEMPEL'S THINNER 08080 (xylene)	HEMPEL'S THINNER 08080 (xylene)
7825/7821	HEMPEL'S THINNER 08080 (xylene)	HEMPEL'S THINNER 08080 (xylene)
All FC75##/FC796# Materials	Odorless Reducer 7055	HEMPEL'S THINNER 08080 (xylene)
All RTS PMMA/PUMA Materials	Do Not Thin	800 RTS PMMA Cleaning Agent
Acrylithane HS2 & HS4	21092	MEK
Ureprime™ HS2 & HS4	21092	MEK

Reading Lot/Batch Numbers

Lot numbers—also called batch numbers—show when and where material was produced. They allow Neogard to track purchases of material, and in the event of problems, lot numbers allow technical personnel to test materials retained by the factory for quality control/assurance.

Lot numbers allow the customer to determine the age of material and if it has reached its maximum shelf life. Customers can also use lot numbers for their own records on material.

Lot numbers are shown on the labels of material buckets or cans, as shown below:



-a part of the HEMPEL Group

NEOGARD URETHANE DECK COATING 7430 GRAY

Contains (US Gallon)

5

Lot. No.: **399090378**

Gray

57040 16650

Made in USA – Hecho en: E.U.A.
VOC / COV / VOC: 220.8 g/l

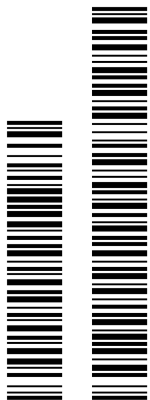

57040 16650 G005

APPLY WITHOUT ADDITIONAL SOLVENT
REDUCTION.

LIMITED WARRANTY NOTICE:
Manufacturer provides a limited warranty for this product. For warranty details, please go to www.neogard.com. **MANUFACTURER MAKES NO OTHER WARRANTIES THAT EXTEND BEYOND THE WARRANTY REFERENCED ABOVE, INCLUDING, WITHOUT LIMITATION, ANY IMPLIED WARRANTIES OF MERCHANTABILITY OR FITNESS FOR A PARTICULAR PURPOSE. MANUFACTURER WILL NOT BE LIABLE FOR ANY INCIDENTAL OR CONSEQUENTIAL DAMAGES FOR BREACH OF ANY EXPRESS OR IMPLIED WARRANTY, OR THAT ARISE IN ANY WAY IN RELATION TO THIS PRODUCT.** Buyer is responsible for determining the suitability of the intended use of this product, and manufacturer disclaims all responsibility for the use, handling and storage of this product.

NEOGARD, a Division of Hempel (USA), Inc. 2728 Empire Central
Dallas, TX 75235, Tel. 1-214-353-1600

Lot No.: 399090378

39: Factory Code (39 Dallas. 42 Conroe)

9: Last digit of year produced (2019)

09: Month produced (September)

0378: Sequential manufacturing number

Primers

When applied directly to concrete or plywood, Neogard traffic systems typically require a primer. A primer may be required when recoating an existing system.

Within 24 hours of applying primer, Base Coat must be applied. If Base Coat cannot be applied within 24 hours, inspect surface for contaminants, clean surface as necessary, and re-prime.

Below are the most frequently recommended primers, along with a brief description of uses and limitations. For information on specialty primers for metal and existing coating systems, contact Neogard Technical Services at www.Neogard.com.

Caution: Do not apply epoxy primers over urethane sealants.

Hempel product numbers in parentheses.

Note: Pot life times are approximate.

7797/7798 (254JB)

Two component, high solids, low odor urethane. Typically used as a rebond or recoat primer over existing urethane coatings and as a general purpose primer for use on concrete and most metal substrates.

- Mix Ratio: 2:1
- Kit Size: 3-gallon
- Pot Life: 30–40 minutes
- Cure Time: 6 hours at 75°F/23°C.

7760/7761 (25100)

Two component, solvent-borne epoxy. Most commonly used with Neogard single component, solvent-borne systems including Auto-Gard and Peda-Gard, where odor and low VOC are not a concern.

- Mix Ratio: 1:1
- Kit Size: 2- or 10-gallon
- Pot Life: 3–4 hours.
- Cure Time: 1.5 hours at 75°F/23°C.

7780/7781 (280JB)

Two component, water-borne epoxy. Typically recommended for use with Neogard two-component, high solids, low odor, low VOC Auto-Gard FC and Peda-Gard FC systems. This primer may also be used with standard Auto-Gard and Peda-Gard systems.

- Do not apply if temperatures are 40°F or below during curing process.
- Mix Ratio: 4:1
- Kit Size: 5-gallon
- Pot Life: 6 hours (Note: do not use mixed material after 6 hours)
- Cure Time: 1.5 hours at 75°F/23°C.

7740/7741 (252JB)

Two component, ultra-high solids epoxy. Moisture tolerant, specifically designed for the Pool-Gard C system although it can also be used as a primer for any of the Neogard traffic-bearing waterproofing systems.

- Mix Ratio 2:1
- 3-gallon kit.
- Pot Life: 2 hours.
- Cure Time: 5 hours at 75°F/23°C.

70714/70715 (45060)

High performance, 100% solids epoxy. Can be used as a primer for any of the Neogard traffic bearing waterproofing systems, and as a concrete overlay or re-surfacer. Low odor, moisture tolerant, low VOC, and may be applied in high humidity environments.

- Mix Ratio: 2:1
- Kit Size: 3- or 15-gallon
- Pot Life: 30 minutes.
- Cure Time: 8–9 hours at 75°F/23°C.

70714/70715-01 (45061)

High performance, fast-set version of 70714/70715 100% solids epoxy. Can be used as a primer for any of the Neogard traffic bearing waterproofing systems and as a concrete overlay or re-surfacer. Low odor, moisture tolerant, low VOC, and may be applied in high humidity environments.

- Mix Ratio: 2:1
- Kit Size: 3- or 15-gallon
- Pot Life: 15 minutes.
- Cure Time: 2–3 hours at 75°F/23°C.

70714/70715-09 (45062)

General purpose, 100% solids epoxy. Can be used as a primer for any of the Neogard traffic bearing waterproofing systems, and as a concrete overlay or re-surfacer. Low odor and low VOC. Avoid use in high humidity environments; this product is less moisture tolerant than 70714/70715 and 70714/70715-01, and blushing may occur.

- Mix Ratio: 2:1
- Kit Size: 3- or 15-gallon
- Pot Life: 60 minutes
- Cure Time: 8–9 hours at 75°F/23°C.

100 RTS (256JB)

Methyl-methacrylate (MMA) primer only for use with Neogard PMMA/PUMA RTS systems. Can be applied at temperatures as low as 23°F (-5°C). Contact Neogard if applying below 30°F (-1°C). Must be mixed with Neogard 600 RTS BPO Initiator (see dosage chart in this Support Information section).

- Kit Size: 5-gallon (4.5-gallon fill)
- Cure Time: 30–60 minutes (depending on temperature)

RTS BPO Initiator Dosage Chart

		BPO Initiator Dosage by Ambient Air Temperature (fluid ounces per gallon)												
		30 °F -1 °C	35 °F 2 °C	40 °F 4 °C	45 °F 7 °C	50 °F 10 °C	55 °F 13 °C	60 °F 16 °C	65 °F 18 °C	70 °F 21 °C	75 °F 24 °C	80 °F 27 °C	85 °F 27 °C	90 °F 32 °C
Product	100 RTS	12	11	10	9	8	7	6	5	4	3.5	3	2.5	2
	200 RTS	12	11	10	9	8	7	6	5	4	3.5	3	2.5	2
	300 RTS	12	11	10	9	8	7	6	5	4	3.5	3	2.5	2
	400 RTS	6	6	5	5	5	4	4	4	3	3	3	2.5	2

Additives

Accelerators

The following liquid additives to be used with single and two component urethane coatings to accelerate the cure. They are intended for low temperature applications as well as conditions requiring earlier use than the physical properties could have developed under ambient conditions. Keep the materials and accelerators as close as possible to ambient temperature 70°F (21°C) prior to mixing and application.

Hempel product numbers in parentheses.

- 7923 (95053): Standard accelerator for Neogard single-component, solvent-borne, aromatic and aliphatic urethanes. Mix ratio: 1 pint 7923 per 5 gallons of urethane.
- 7925 (991JB): “Fast” accelerator for Neogard single-component, solvent-borne, aromatic and aliphatic urethanes. Mix ratio: 1/2 pint 7925 per 5 gallons of urethane.
- 7931 (99055): Low humidity accelerator for Neogard single-component, solvent-borne, aromatic and aliphatic urethanes. Mix ratio: 1/2 pint 7931 per 5 gallons of urethane. Can also be used with Neogard FC7510/FC7961, FC7540/FC7964 and FC7545/FC7964. Note: Do not use 7931 with FC7500/FC7960 or FC7530/FC7563.

Always pre-mix the material thoroughly prior to the addition of the accelerator. Time will vary depending on temperature conditions. Add the accelerator slowly at the end of the pre-mix while still mixing. Continue to mix 20 minutes for 55-gallon drums and 5 minutes for 5-gallon buckets.

Vertical Additive

- 7922 (990JB): Vertical Additive is designed to enhance the sag resistant properties of Neogard single component, solvent borne, aromatic urethane coatings only, with a 30 minute induction time.

Note: 7922 creates an accelerator effect and quickly reduces pot life.

Product	7922 Per 5 Gallons	Sag Resistance (mls)
7430 series	2 x 1/2 Pint	14–16
70410	1/2 Pint	14–16
7470	Do Not Use	N/A

Odor Masks

- 7986 (994JB): A synthetic vanilla odor mask for single component urethanes. Use at a rate of 3 oz. per 5 gallons or 1 quart per 55 gallons of product.

- 7987 (995JB): An orange-scented odor mask for single component urethanes. Bio-based/biodegradable solvent, rated per FDA guidelines as Generally Recognized As Safe (GRAS). Use at a rate of 3 oz. per 5 gallons or 1 quart per 55 gallons of product.

Caution: Do not exceed these dosage rates without consulting Neogard Technical Service.

Surface Conditioners for Structural Concrete Decks

Surface conditioners are used to fill voids, areas of aggregate loss and excessively rough, damaged or exposed aggregate surfaces prior to the application of Neogard Auto-Gard and Peda-Gard traffic bearing waterproofing systems in order to assure effective installation and long term performance.

Neogard offers two variations of surface conditioners for patching or resurfacing structural concrete decks:

- 70702/70703: Two component, 100% solids epoxy slurry that is specially formulated to resurface deteriorated concrete to leave a smooth, durable finish.
- 70714/70715-09: Two-component, 100% solids epoxy resin, designed as an economical super high strength binder. A 1:1 by volume mix of #200 fumed silica flour and mixed 70714/70715-09 makes an excellent concrete surface conditioner. The following mix will yield approximately 4.8 gallons of mixed material. Spread at approximately 50 square feet per gallon.

Application Methods

- For a smooth surface, apply epoxy slurry mix to effected areas with a notched squeegee and allow to cure. Do exceed 1/4" in depth per application.
- For filling in depressed, scaled or exposed aggregate areas of the structural slab, spread epoxy slurry mix to affected areas with a notched squeegee and immediately broadcast 16-30 mesh aggregate into wet mix to rejection. Do not exceed 1/2" in depth per application. Allow to cure and remove excess aggregate.

Note: The surface profile obtained by broadcasting 16-30 mesh aggregate into the epoxy slurry will leave a rough surface and will require a grout coat of neat epoxy applied at the rate of 1/2 gallon per 100 square feet or a fill coat of polyurethane Base Coat at the rate of 3/4 gallon per 100 square feet prior to the application of either Auto-Gard or Peda-Gard. In lieu of applying the epoxy neat coat or polyurethane Base Coat, surface can be ground smooth with the use of terrazzo or portable cup grinders.

Consult these products' SDS for instructions on safety and handling.

Epoxy Patching

Neogard 70714/70715 series epoxies are two-component, 100% solids epoxy resins, specially formulated to use in dry, damp or humid environments and have excellent chemical resistance.

Note: 70715/70715-09 is moisture sensitive and is not recommended for use in damp or humid conditions.

Surface Preparation

- Remove dust, laitance, grease, curing compounds, waxes and other foreign materials.
- Prepare concrete by shot-blasting, acid etching or diamond grinding.
- Surface must be clean and sound before patching.

Mixing

- Always read labels for mix ratios.
- Improper mix ratios can result in soft or uncured material.
- Always use clear 70714/70715, 70714/70715-01 or 70714/70715-09. Use a slow speed drill (600 rpm) with a Jiffy Mixer paddle. Mix only what can be used within the pot life of the material. Refer to Neogard Product Data Sheets for pot life information.

Application

- For minor patches and cracks up to 3/4" wide and 1/2" deep, mix P1934 fumed silica mixed with clear 70714/70715, 70714/70715-01, or 70714/70715-09 epoxy at a ratio of 3 parts of silica to 1 part of mixed epoxy by volume.
- Place the patching material onto cracks, holes, or pop outs and then strike flush with a putty knife or trowel. Let cure before installing the flooring system.
- For major patches and cracks greater than 3/4" wide and 1/2" deep, mix 86364 aggregate mixed with clear 70714/70715, 70714/70715-01, or 70714/70715-09 epoxy mixed at a ratio of 4 parts of 86364 to 1 part of mixed epoxy by volume.

Note: 1 gallon of mixed epoxy and 4 parts of 86364 aggregate will cover 21.7 square feet at 1/4" depth.

- Apply with a trowel and finish off level with surrounding surfaces.
- For larger area resurface patching, mix clear 70714/70715 or 70714/70715-09 epoxy with 86468 silica flour at a ratio of 1:1 by volume to make a slurry.
- Apply with a notched trowel or squeegee to desired thickness and then broadcast 86364 or 7992 silica sand to refusal.

Weather Impact on Coating Materials

Neogard single-component and two-component polyurethanes are designed to be applied through an ambient temperature range of 70°–90°F (21°–32°C) to provide ideal handling and application characteristics.

Cold Weather Impact

Caution: Substrate temperatures can affect the cure of polyurethane materials as much as or more than ambient temperatures. Application of heated material to a cold substrate will not reduce the curing time. Consult Neogard for recommendations.

As material component temperatures become colder and start to drop below 60°F/15°C, they increase in material viscosity. An increase in material viscosity increases the material's resistance to flow and can result in the following:

- Single-component systems that utilize accelerators become difficult to mix. If the accelerator is not thoroughly mixed with the polyurethane, curing of the material will slow.
- Two-component systems also become more difficult to mix together. If a thorough mix is not obtained, the off-ratio mixture can cause improper curing.
- Polyurethanes become more difficult to spray. They produce erratic spray pressures, poor atomization, fingering at the spray tip or a complete loss of the spray pattern. Some applicators are tempted to add solvent to the polyurethane material so that it can be sprayed. Adding solvent will slow the cure time, change the thixotropy, and change the dry film thickness. All of this can lead to material puddles, uneven coating coverage, and added expense to the job cost due to downtime.

- Accelerators and catalysts are packaged to provide good pot life and reasonable cure of materials at 70°F–90°F (21–32°C). As material temperatures become colder and start to drop below 60°F (15°C), the pot life of the material is increased and the speed of the cure may be severely reduced. If the material is applied at 60°F/15°C (material temperature) and the air temperature drops to 40°F/4°C or below, the cure is slowed down, particularly if windy conditions exist. The cure is further retarded due to slow solvent evaporation in cold temperatures. Materials that normally cure at a rate of 8–12 hours can be extended to 14–24 hours or more.

Keep enough material at 70°F–80°F (21–26°C) for about two days of work. This will minimize the storage space required to keep the material warm. Refer to “Additives” and “Curing Charts” in the Support Information section of this manual when these conditions exist. When possible, apply the coatings earlier in the day, making sure the substrate is dry, and quit early enough to allow several hours of cure from the sun. Remember, if the application area is enclosed with no exchange of air over the membrane, the relative humidity (moisture) may be severely reduced, resulting in a slow curing time.

Hot Weather Impact

High substrate, ambient, and material temperatures can impact material viscosity and accelerate the curing process. Single-component, solvent-based products cure from the top down. If the surface of the coating skins over too quickly, the solvents released during the curing process become trapped, resulting in blisters and/or bubbles in the coating. Two-component products are also affected by high temperatures. Pot life and working time can be reduced significantly. To minimize the impact of high temperatures during coating application do the following:

- Store material in a cool, dry place; never in direct sunlight or in areas of high temperatures. The mixing station should also be in a shaded area.
- Consider coating in the evening as the substrate cools, or if applicable, on the shady side of the building. This will help to minimize outgassing as the material cures and extend working time of the material.
- As the material viscosity decreases, the sag resistant properties will also be affected. In sloped areas, it may be necessary to apply the specified system in thinner coats, increasing the number of coats required to apply the full system. Neogard 7922 Vertical Additive is compatible with most Neogard single-component, solvent-based coatings and will enhance the sag resistance properties of the coating material. Contact Neogard Technical Services for specifics.

Dew Point of Moist Air

The Neogard Technical Guide Troubleshooting Manual can be found at www.Neogard.com. It offers additional solutions for many of the challenges presented by both weather impact and project conditions.

Dew Point is the temperature at which moisture will condense on a surface. No coatings should be applied unless surface temperature is a minimum of 5°F/3°C above this point. Temperature must be maintained during curing.

(continued on next page)

Dew Point Table

		Ambient Air Temperature										
		20°F -7°C	30°F -1°C	40°F 4°C	50°F 10°C	60°F 16°C	70°F 21°C	80°F 27°C	90°F 32°C	100°F 38°C	110°F 43°C	120°F 49°C
Relative Humidity	90%	18°F	28°F	37°F	47°F	57°F	67°F	77°F	87°F	97°F	107°F	117°F
	85%	17°F	26°F	36°F	45°F	55°F	65°F	75°F	84°F	95°F	104°F	113°F
	80%	16°F	25°F	34°F	44°F	54°F	63°F	73°F	82°F	93°F	102°F	110°F
	75%	15°F	24°F	33°F	42°F	52°F	62°F	71°F	80°F	91°F	100°F	106°F
	70%	13°F	22°F	31°F	40°F	50°F	60°F	68°F	78°F	88°F	96°F	105°F
	65%	12°F	20°F	29°F	36°F	47°F	57°F	66°F	76°F	85°F	93°F	103°F
	60%	11°F	19°F	27°F	36°F	45°F	55°F	64°F	73°F	83°F	92°F	101°F
	55%	9°F	17°F	25°F	34°F	43°F	53°F	61°F	70°F	80°F	89°F	96°F
	50%	6°F	15°F	23°F	31°F	40°F	50°F	59°F	67°F	77°F	86°F	94°F
	45%	4°F	13°F	21°F	29°F	37°F	47°F	58°F	64°F	73°F	82°F	91°F
	40%	1°F	11°F	18°F	26°F	35°F	43°F	52°F	61°F	69°F	78°F	87°F
	35%	-2°F	8°F	16°F	23°F	31°F	40°F	48°F	57°F	65°F	74°F	83°F
	30%	-6°F	4°F	13°F	20°F	28°F	36°F	44°F	52°F	61°F	69°F	77°F

Example: If ambient air temperature is 70°F and relative humidity is 65%, the dew point is 57°F (14°C). No coating should be applied unless the surface temperature is 62°F (17°C) minimum (57°F + 5°F = 62°F).

Sample Curing Charts

Please refer to the Neogard Product Data Sheets for accelerators/additives that are appropriate for a specific product. Examples of how these accelerators can affect recoat times are as follows:

FC7540/FC7964

Conditions		50°F (10°C), 50% relative humidity	59°F (15°C), 50% relative humidity
Accelerator	Amount	Cure Time	Cure Time
None	None	9 hours	6 hours
7931	0.5% by volume	4.5 hours	2 hours
7931	1.0% by volume	3.5 hours	1.5 hours

70410

Conditions		40°F/4°C, 60% relative humidity		75°F/23°C, 50% relative humidity		95°F (35°C), 50% relative humidity	
Accelerator	Amount	Pot Life	Recoat Time	Pot Life	Recoat Time	Pot Life	Recoat Time
None	None	>7 days	48 hours	> 7 days	14 hours	> 7 days	12 hours
7931	4 oz/5 gal	> 24 hours	22 hours	> 24 hours	10 hours	> 24 hours	8 hours
7931	8 oz/5 gal	> 24 hours	21 hours	> 24 hours	7.5 hours	> 24 hours	6 hours
7931	16 oz/5 gal	> 24 hours	23 hours	> 24 hours	9 hours	12 hours	7 hours

Conditions		40 °F/4 °C, 60% relative humidity		75 °F/23 °C, 50%relative humidity		95 °F (35 °C), 50% relative humidity	
Accelerator	Amount	Pot Life	Recoat Time	Pot Life	Recoat Time	Pot Life	Recoat Time
7923	8 oz/5 gal	> 24 hours	20 hours	12 hours	10 hours	8 hours	8 hours
7923	16 oz/5 gal	11 hours	13 hours	4 hours	7 hours	2.5 hours	5.5 hours
7925	8 oz/5 gal	5 hours	23 hours	2.6 hours	8 hours	2.3 hours	6 hours
7925	12 oz/5 gal	3 hours	20 hours	1 hr	6.5 hours	1 hr	5 hours
7925	16 oz/5 gal	3 hours	14 hours	0.5 hours	5 hours	0.5 hours	4.5 hours
7925	20 oz/5 gal	2.5 hours	11 hours	0.3 hours	4.5 hours	0.3 hours	4 hours

7430

Conditions		40 °F/4 °C, 60% relative humidity		75 °F/23 °C, 50%relative humidity		95 °F (35 °C), 50% relative humidity	
Accelerator	Amount	Pot Life	Recoat Time	Pot Life	Recoat Time	Pot Life	Recoat Time
None	None	>7 days	37 hours	> 7 days	14 hours	> 7 days	11 hours
7931	4 oz/5 gal	> 24 hours	24 hours	> 24 hours	12 hours	> 24 hours	10 hours
7931	8 oz/5 gal	> 24 hours	20 hours	> 24 hours	9 hours	>14 hours	8 hours
7931	16 oz/5 gal	> 24 hours	10 hours	>16 hours	6 hours	11 hours	5 hours
7923	8 oz/5 gal	> 24 hours	26 hours	15 hours	12 hours	12 hours	10 hours
7923	16 oz/5 gal	20 hours	20 hours	10 hours	13 hours	8 hours	9 hours
7925	8 oz/5 gal	> 24 hours	12 hours	> 24 hours	5 hours	> 24 hours	5 hours
7925	12 oz/5 gal	20 hours	8 hours	8 hours	3.5 hours	6.5 hours	3 hours
7925	16 oz/5 gal	8 hours	6 hours	1.7 hours	2.5 hours	1.5 hours	2 hours

70613

Conditions		40 °F/4 °C, 60% relative humidity		75 °F/23 °C, 50%relative humidity		95 °F (35 °C), 50% relative humidity	
Accelerator	Amount	Pot Life	Recoat Time	Pot Life	Recoat Time	Pot Life	Recoat Time
None	NA	>7 days	48 hours	>7 days	14 hours	>7 days	11 hours
7931	16 oz	>24 hours	18 hours	>24 hours	6 hours	12 hours	6 hours
7923	8 oz	>24 hours	20 hours	12 hours	8 hours	8 hours	7 hours
7923	16 oz	11 hours	13 hours	4 hours	7 hours	2.5 hours	5 hours

Safety and Storage

This section covers safety and storage of Neogard coating materials. Failure to follow these instructions may result in bodily injury or property damage.

General Guidelines

SDS must be on jobsite at all times.

Neogard produces three basic material types: 100% solids epoxies; cement-based, water-dispersed urethanes; and solvent borne urethanes. Each type has specific hazard potentials and storage requirements. Urethane coatings have hazards associated with fire, solvent toxicity, and chemical toxicity. 100% solids epoxies have low fire risk but may require special care because of chemical toxicity. Everyone on the jobsite must know how to protect against fire, explosion, and toxicity. Refer to SDS, product labels, product data sheets and application specifications which describe specific hazards content, proper use, and storage procedures.

Provide ventilation at all times, especially when working indoors or in confined areas. When natural air movement is insufficient, forced air ventilation is required. Use equipment which exhausts the air from near floor level, since solvent vapors are heavier than air and collect in low areas. A competent, properly equipped person must be stationed outside confined areas during work to assist in case of emergency.

Fire and Explosion Prevention

Neogard lists flash points for products containing solvents on the product's Product Data Sheet (PDS). The flash point is the lowest temperature at which a coating gives off sufficient solvent vapor to form an ignitable mixture with air. This mixture of solvent vapor and air can then be ignited by an outside source such as sparks, flame, lit cigarettes, and others.

Open flame, welding, smoking or other ignition sources shall not be allowed in a building, overhead, or near a building where coating is being applied or was recently applied. Keep ignition sources downwind of a coating operation. No smoking, welding or open flame shall be allowed near areas where air with solvent vapor is being discharged.

All electrical equipment and outlets must be grounded, including switches, connectors, lights and motors. Lights must have a protective enclosure to prevent physical damage. Whenever solvent vapors are present, all electrical equipment must be explosion proof. Contractor and applicator personnel are responsible for these precautions; a contractor or applicator employee must be appointed this duty.

Any equipment—such as spray guns and compressed air nozzles—that can produce a static charge must be grounded. All hand tools used in solvent vapor areas must not produce sparks. When non-complying tools must be used, move equipment to an area free of solvent vapor or thoroughly exhaust solvent-laden air before beginning work.

Work clothes must be of a material which does not generate static charges. Beware of synthetic materials. Shoes shall not have metal sole plates since these cause sparking.

Have fire extinguishers as prescribed by the Occupational Safety and Health Administration (OSHA) within easy access of work areas where solvent coatings are being applied. Dry chemical and CO₂ (carbon dioxide) extinguishers are effective in controlling small solvent fires.

Ventilation shall be provided to coated areas not only during application, but also for sufficient time after application to assure complete evaporation of solvents.

Toxicity and Health Considerations

Inhalation of solvent vapors in high concentration, above 200 parts per million, can induce narcosis, a physiological effect similar to intoxication by alcohol. Continued exposure to high concentration can cause loss of consciousness and ultimately death. The maximum allowable concentration of solvent vapors on a weighted eight hour working day is limited to 100 parts per million as published by OSHA. This is a concentration at which nearly all workers can be repeatedly exposed without adverse effects.

Small, portable air sampling equipment is available to measure the content of some solvents in the air. Applicators must measure solvent content in the air when people are working in an enclosed area.

Approved respirator masks (chemical cartridge vapor masks) may be used to protect against low concentrations of solvent vapor (below 200 PPM). At higher vapor concentrations, this type of mask will not provide adequate protection. Replace mask cartridges on a regular basis.

Note: Proper selection of respirators shall be made according to the guidance of American National Standard Practices for Respiratory Protection Z88.2-1992.

An approved fresh air supplied respirator with approved source of respirable air must be used for protection when solvent vapor concentrations are high (above 200 PPM). Use of fresh air supplied respirators does not reduce the necessity for good ventilation to reduce fire hazards and ensure proper drying of coatings.

- Air quality: Compressed air, compressed oxygen, liquid air, and liquid oxygen used for respiration shall be of high purity. Oxygen shall meet the requirements of the United States Pharmacopeia for medical or breathing oxygen. Breathing air shall meet at least the requirements of the specification for Grade D breathing air as described in Compressed Gas Association Commodity Specification G-7.1-1966. Compressed oxygen shall not be used in supplied-air respirators or in open circuit self-contained breathing apparatus that have previously used compressed air. Oxygen must never be used with air line respirators.
- Breathing air may be supplied to respirators from cylinders or air compressors.
- Cylinders shall be tested and maintained as prescribed in the Shipping Container Specification Regulations of the Department of Transportation (49 CFR part 178, Subpart C). Compressors for supplying air shall be equipped with necessary safety and standby devices. A breathing air-type compressor shall be used. Compressors shall be constructed and situated so as to avoid entry of contaminated air into the system and suitable in-line air purifying sorbent beds and filters installed to further assure breathing air quality. A receiver of sufficient capacity to enable the respirator wearer to escape from a contaminated atmosphere in event of compressor failure, and alarms to indicate compressor failure and overheating shall be installed in the system. If an oil-lubricated compressor is used, it shall have a high-temperature or carbon monoxide alarm, or both. If only a high-temperature alarm is used the air from the compressor shall be frequently tested for carbon monoxide to ensure that it meets the specifications noted in air quality above. Air line couplings shall be incompatible with outlets for other gas systems to prevent inadvertent servicing of air line respirators with non respirable gases or oxygen.

Any time a worker feels discomfort or irritation to the eyes, nose, or throat, the concentration of solvent vapor is too high for steady exposure. If a person feels light headed, giddy, dizzy, or exhilarated, the solvent vapor concentration is also too high and must be reduced by better ventilation. Anyone affected must go to an area with fresh air.

Effective ventilation depends on the physical barriers which restrict air flow. Open exterior areas on decks ventilate normally by natural air movement. Confined areas in rooms, pits or ponded areas, and decks surrounded by walls or high parapets require forced air ventilation.

Most people do not find solvent vapors irritating to the skin, even in high concentrations. Contact with liquid solvent has a drying effect on the skin; however, most people find no lasting effects. Special hand creams can be used to protect people who handle Neogard solvents or coatings frequently. Protect the sensitive areas of the face, armpits and groin from contact with solvent. These areas can suffer an astringent burn and should be washed with soap and water immediately if exposed to liquid solvents.

Some people have a very low resistance to irritants. Should a person develop respiratory problems or skin rash, have him or her consult a physician. Particularly sensitive individuals may have to be assigned to work free of exposure to solvents or, in some cases, certain chemicals.

Should solvent or solvented coatings be splashed in the eye, flush immediately with water; then consult a physician.

Other Health Considerations

Safety shoes with steel toe protection must be worn. The sole should be of a soft, resilient material to give best traction without damaging coated areas. Fifty-five-gallon drums of coating are very heavy and can cause considerable damage if set on an unprotected foot.

Use extreme caution when working on sloped areas. Use lifelines. Wet coatings are very slippery.

When working in bright sun with light color coating, wear dark glasses to prevent damage to the eyes.

Property Precautions

Consider possible damage to property. Overspray can ruin finishes on vehicles and other surfaces (brick, paint, plastic, and others). Solvent vapors in confined areas can damage plants and pets, including tropical fish and birds. Food, even stored in freezers, can pick up a solvent taste and should be protected.

Storage

Avoid storing material in direct sunlight. All material should be stored in a cool shaded place, preferably at a temperature of 75°F/23°C. Higher storage temperature for extended periods can cause thickening or gelation of elastomeric coatings.

Whenever work is stopped for the day, all coatings and thinner should be stored in tightly sealed factory containers to prevent evaporation and fire hazard. Materials left on unsupervised job sites may attract the curious or the malicious. Protect your materials properly and avoid potential harm to others. Contractors are responsible for the safety and proper handling of material.

Do not keep open containers in confined places.

Protect emulsion (water borne) coatings from freezing.

Volatile Organic Compounds (VOCs) and Health

Worker Safety and Public Health

VOCs as solvents in paint coatings are regulated by EPA because of their public health hazard. VOCs are one class of chemicals which when released into the air will begin chemical reactions in the atmosphere that result in smog, which is a health hazard to people, especially the young, old, and those with respiratory problems. Some solvents are legally not VOCs, but are still hazardous.

VOCs as solvents in paint coatings are regulated by OSHA because of the occupational exposure hazards to workers in the industries of construction, shipbuilding, and general trades.

Besides VOCs, there are often other hazardous ingredients in coatings that may be regulated by OSHA.

These ingredients include heavy metals in pigments, isocyanates in urethane binders, and several other chemical ingredients.

Zero VOC versus VOC Compliant

Under the EPA's Clean Air Act regulations, use of low-VOC coatings—typically where VOCs are less than 2.1 pounds per gallon (lbs/gal) of paint—is one of the best ways to reduce hazardous air pollutants (actual VOC restrictions vary by area and coating type). Alternative coatings are now available that are essentially “Zero VOCs.” These include waterborne coatings (80% water) and powder coatings (100% solids). These alternative coatings eliminate the VOC problem and are “EPA-friendly,” but they have their own disadvantages in application limitations and they can still contain chemical ingredients that may be hazardous to workers and are regulated by OSHA.

VOCs and Odor

Most, if not all, VOCs have some odor. Some VOC-exempt solvents have odor. Certain binders and pigments can also have odor. However, the amount or type of odor is not the best measure of the health hazard or toxicity from breathing a certain chemical or compound. Odors are subjective to different people, and some chemicals can saturate the nose, thereby reducing the apparent smell.

The best way to measure the toxicity of a chemical is by laboratory testing. The best way to measure a person's exposure to a chemical is by using air sampling and laboratory analysis. When this air sampling is for a worker in an occupational setting, it is part of the OSHA-recognized practice of industrial hygiene.

Odor cannot be ignored, as it is often the most difficult issue that a building owner or employer using chemicals has to deal with, regardless of the toxicity. In some cases, a so-called “VOC-free” paint coating can be more odorous than a “low-odor” coating that contains small amounts of VOCs. The mere perception of irritating odors is enough to warrant an owner to consider sacrifices in cost and product performance just to buy some “peace of mind” and reduce the risk of complaints or lawsuits from the building occupants and neighbors. On the other hand, some product specifiers may insist on “VOC-free” coatings, whereas the “low-odor” coating with small amounts of VOCs would perform better as a coating and may even have a less irritating odor than the “VOC-free” coating.

Air Testing Needed For Coating Applications

Air testing is driven by the owner's concerns and the employer's responsibilities. Relatively few chemicals and substances are used in paint coatings for which OSHA requires the employer to collect air samples during the paint application. An example of where OSHA sampling is required is when coatings contain the heavy metals of lead or chromium.

If conditions of the application are extreme—such as a confined area with no ventilation—it's best to take extra measures to reduce exposures (e.g., safer paints, added ventilation, and respirators) for workers. Air sampling can verify the adequacy of these control measures. The owner often requires air sampling to address concerns that nearby occupied areas are not being contaminated by the coating application. VOCs are often the target of air sampling, but some other constituents of coatings are hazardous and should have their exposures evaluated.

An industrial hygienist typically makes a judgement on what and when to air sample, considering all of the above factors and issues. The hygienist first identifies the paint coating ingredients as listed on the manufacturer's SDS. This document lists hazardous ingredients, known hazards and health effects, and known exposure limits, as established by OSHA or recommended by a professional body, such as the American Conference of Government Industrial Hygienists (ACGIH).

Conclusion

The above information is based on standard industrial practices and is meant to outline the hazards, but

is not necessarily all inclusive. Local conditions on specific jobs may require other precautions. Common sense and care in evaluating the possibility of hazards is essential.

Nothing contained herein should supersede local laws, codes, ordinances or regulations, or the instructions of other manufacturers for the use of their products.

The standards and regulations published by OSHA, U.S. Department of Labor, where applicable, should be consulted for further detail and compliance.

Glossary

1K & 2K: 1K is a term used to describe a coating that has only one component and does not require a hardener, catalyst or activator. 2K describes a coating that has two components in that the resin side needs to be mixed with a hardener, catalyst or activator.

Accelerator: A chemical typically mixed in small quantities with coating that increases the speed of the chemical reaction thereby hastening the curing of the coating system.

Additive: Product added to coating during mixing that enhances physical or chemical properties.

Activator: The curing agent/hardener of a two component coating system.

Adhesion: The degree of attachment between a coating film and the underlying substrate. There are several test methods to measure the amount of adhesion.

Aggregate: Hard material typically comprised of stone, sand, glass or synthetic material that is added to a coating system to provide build and skid resistance to the final system.

Aliphatic Coating: Type of hydrocarbon that displays aliphatic straight chains or branches as part of its chemistry. Aliphatic polyurethanes have certain improvements in characteristics over aromatics, such as less chalking effect and better color retention, but typically require longer cure times.

Ambient Temperature: Room temperature or the existing temperature of the surrounding air.

Aromatic Coating: Type of hydrocarbon that displays an aromatic (benzene) ring as part of its chemistry. Aromatic polyurethanes are commonly used in moisture cured coating systems.

Base Coat: The first layer of coating applied to the primed surface of a coating system. The Base Coat typically provides the waterproofing capability of a liquid applied coating system.

Below Grade: Part of the structure below ground level. Usually these areas have to be designed to resist the passage of water under hydrostatic head pressure.

Bird Bath: The National Roofing Contractors Association (NRCA) defines a bird bath as random, inconsequential amounts of residual water on a roof membrane.

Blast Cleaning: The cleaning and roughing of a surface by the use of sand, artificial grit, or fine metal shot which is projected at a surface by compressed air or mechanical means.

Boxing: The process of combining all the coating you will be using as the topcoat into one large container. This is especially important when coating a large surface area or if there is insufficient coating from a single batch, where a color variation from one batch to another is likely.

Broadcasting: Evenly distributing over an area (ie. to evenly broadcast aggregate).

Broom Finish: A finishing profile of concrete in which concrete surface is given a final textured finish by dragging a stiff bristled broom over it as it starts to cure.

(continued on next page)

CA Formulated Coating: Coatings that Neogard has formulated to meet the VOC content requirements for coatings established by South Coast Air Quality Management District (SCAQMD), the air pollution control agency for all of Orange County and the urban portions of Los Angeles, Riverside and San Bernadino counties.

Catalyst: An accelerator, activator, or curing agent which chemically increases the rate of reaction in a coating.

CSP (Concrete Surface Profile): CSP is a measurement of roughness of the surface of concrete as determined by set guidelines provided by ICRI (International Concrete Repair Institute). CSP's measure from smooth/flat (CSP 1) to very rough (CSP 9).

Cure: The process of development of fluid applied coatings through the stages of polymerisation. In the application of Neogard coating systems we describe four phases: initial cure, tack-free, traffic cured and fully cured.

Degreaser: A chemical solution or compound designed to remove grease, oil, and similar contaminants.

Dew Point: The temperature of air at which condensation of moisture will occur.

DFT (Dry Film Thickness): Thickness of coating measured in Mills after coating has fully cured and thus taken its solid form. DFT is always equal to or less than WFT depending on the percent of solids contained within the coating.

Direct Bond: Neogard roof coating systems designed to be applied directly to existing non-ballasted single-ply membranes, granulated cap sheet, modified bitumen, concrete, metal and smooth surface BUR roof substrates.

Elastomeric: Products that are "elastic" in nature and are capable of withstanding significant movement as seen in some building structures.

Etching: The treatment of the surface of concrete with an acid in order to dissolve loose particles and laitance and/or provide a profile.

Expansive Concrete: Concrete designed to offset the effects of curing shrinkage.

Film: A monolithic layer of coating.

Film Build: The dry film thickness of a coat.

Flash Point: The flash point of a material is the lowest temperature at which it can vaporize to form an ignitable mixture in the air.

Fully Cured: Describes the fluid applied coatings cure phase at which materials have reached the physical properties required to withstand the traffic, use, and exposures for which they are designed.

Granule: A mineral which may be granite or sand used on the top of some coatings for ultraviolet protection, and fire protection.

Grout Coat: The first coat of epoxy over a trowelled flooring system, designed to lock in or seal the epoxy mortar.

Hardener: A chemical co-reactant that activates and/or accelerates the curing of a product to produce a coating film.

High Build : A term referring to a coating that can produce a thick film in a single coat.

Initial Cure: Describes the fluid applied coating cure phase during which the material is progressing from a liquid or gel to tack free.

Jiffy Mixer: A cylindrical mixing tool used for mixing coatings that does an excellent job of preventing air entrapment. It is manufactured exclusively by the Jiffy Mixer Company.

Laitance: An accumulation of fine particles, loosely bonded, on the surface of fresh concrete, caused by upward migration of moisture through the concrete.

Liquid Applied Membrane: A seamless coating system applied to a substrate that protects the substrate from the environment and/or traffic.

MEK (Methyl Ethyl Ketone): A commonly used solvent which has good solubility for most urethanes and some other coatings.

Mesh (Sieve Size): The size of a particle or aggregate reported in fraction of inch. A number 12 sieve is 1/12th of an inch; a number 60 sieve is 1/60th of an inch.

Mil: A Mil is one thousand of an inch (0.001"). It is a unit typically used in the measurement of coating thickness with the help of a Mil Gauge.

Mil Gauge: A device used to measure the thickness of coating while in a liquid state.

Mortar: A heavy application of coating (50 to 250 Mils thick) typically involving use of aggregate either mixed or broadcast. Mortars can be of three types:

- Broadcast: Neat resin over the substrate and where the aggregate is broadcast into the resin while it is still wet.
- Slurry: Very fine aggregate (consistency of flour) is mixed into the resin to create a self leveling consistency.
- Trowel: A blend of medium to fine aggregates is mixed into the resin to create a paste consistency that can be troweled.

Muriatic Acid: Hydrochloric acid often diluted with water and used for etching concrete.

NRCA: National Roofing Contractors Association.

Odor Mask: Chemical with pleasant/non offensive odor which is mixed into coating to mask the coating's odor.

On-Grade: Part of the structure at ground level.

pH: A measure of acidity and alkalinity; pH 1–7 is acid and pH 7–14 is alkali.

Ponding Water: Neogard defines roofing ponding as "water that remains on a roof surface longer than 48 hours after the termination of the most recent rain event.

Porcupine Roller: Spine quill appearing roller that releases bubbles trapped in the more viscous coatings.

Pot Life: The length of time a coating material is useful after its original package is opened or a catalyst or other curing agent is added. At the end of the pot life the product's viscosity increases so much to make it difficult/impractical to apply.

Primer: The first coat applied to a surface, formulated to have good bonding, wetting and inhibiting properties. Primers act as a bond between the substrate and coating system.

Relative Humidity: The ratio, expressed as a percent, of the quantity of water vapor actually present in the air to the greatest amount possible at a given temperature.

Resin: A class of organic substances used in the making of coating products. Resins are often mixed with smaller quantities of a hardener/activator/catalyst to initiate or speed up the curing process.

Respirator: An apparatus worn over the mouth and nose or the entire face to prevent the inhalation of dust, smoke, or other noxious substances. For coatings products, the Material Safety Data Sheet will outline the need for using a respirator when applying the product.

Safety Data Sheet (SDS): Document available for each product that is intended to provide workers and emergency personnel with procedures for working with and handling that substance in a safe manner.

Seal Coat: The first coating application over a broadcasted flooring system or the final coats over a trowelled flooring system.

Seed and Backroll: A type of coating application method where aggregate is dispersed onto the coating surface and then worked in using a roller. System is then allowed to dry.

Seed and Lock: A type of coating application method where aggregate is dispersed onto the coating surface and allowed to dry. At this point, excess aggregate is blown off the surface and the remaining aggregate is “locked” into the system using additional coating.

Shelf Life: The maximum time interval in which a material may be kept in a usable condition during ideal storage.

Shot-blasting: Abrasive blasting with round iron shot, or any material which retains its spherical shape, for substrate roughening purposes.

Solids By Volume: The percentage of the total volume of substance occupied by nonvolatile compounds.

Solids by Weight: The percentage of the total weight of substance occupied by nonvolatile compounds.

Solvent: A liquid in which another substance may be dissolved, forming a solution.

Spalling: Type of concrete surface erosion in which inverted cones of concrete break away from main body and thereby reveal exposed aggregate.

SPF: Spray Polyurethane Foam, defined by the Spray Polyurethane Foam Alliance is a spray-applied insulating foam plastic that is installed as a liquid and then expands many times its original size.

Spray: A common application method in which a person pressurizes the liquid and releases the liquid through an orifice onto the substrate. Alternate application methods are by using a roller or trowel.

Square: A measurement used frequently in roofing, equal to 100 square feet.

Squeegee: A flat rubber blade typically used to distribute coating evenly on the substrate surface. Squeegees may be flat or notched depending on the type of work being done.

SRI: Solar Reflectivity Index is defined by the U.S. Green Building Council as “a measure of the constructed surface’s ability to stay cool in the sun by reflecting solar radiation and emitting thermal radiation.”

Tack Free: Describes the fluid applied coating cure phase during which the material is progressed beyond initial cure but has not yet reached the cured phase. Tack free material will not displace, print, track, or damage when touched or walked on while continuing the system application, while remaining soft enough to coat without requiring additional surface preparation or priming.

Thinning Agent: A liquid (solvent) added to a coating to improve its viscosity and thus make it easier to apply. Common thinning agents include MEK (Methyl Ethyl Ketone), Xylene and Mineral Spirits.

Topcoat: The final layer/layers of coating applied to a liquid applied coating system. Topcoats typically seal in the system and may provide resistance to wear, UV, chemicals, and traffic.

Traffic Cured: Describes the fluid applied coatings cured phase at which the material has progressed beyond tack free but not yet reached fully cured. The cured material has reached the physical properties

required to withstand the various traffic loads progressing from durable to: foot traffic first, light vehicular traffic next, and finally, heavy load traffic.

UV (Ultraviolet) Light: Type of radiation present in sunlight that may have a detrimental effect on some types of coatings causing discoloration/fading and in some cases, premature wearing of the coating system.

Vapor Barrier: A layer which retards the passage of water vapor into a material.

Vapor Drive: The pressure exerted on the underside of a coating system from moisture/water vapor which has migrated through the substrate.

Vapor Transmission Rate: The rate at which moisture passes through a material like concrete or coating system.

Viscosity: A measure of fluidity of a liquid. Easily flowing liquids are low in viscosity and slow flowing liquids are high in viscosity.

VOC (Volatile Organic Compounds): Organic compounds that evaporate from the coating as it cures.

Waterproofing: The use of coating systems for the resistance of the passage of water.

Wear/Intermediate Coat: A layer of coating applied in between the Base Coat and Topcoat of a liquid applied coatings system. Wear/Intermediate coats typically provide build and wear resistance for the coating system.

WFT (Wet Film Thickness): Thickness of coating measured in Mils typically right after the application of the coating product while coating is still in its liquid form.

Xylene Thinner: A common solvent used to dilute certain epoxies and urethanes and also to clean equipment.



Neogard, A part of Hempel, manufactures high-performance coatings specified and used for structures across the globe for over 60 years. Neogard's coating systems protect the building envelope through vehicular and pedestrian traffic coatings, protective roof coatings, seamless flooring and elastomeric wall coatings.

You can find Neogard coatings in Major Stadiums and Arenas, Office Buildings, Universities, Hospitals, Hotels and Casinos, Airports and Hangers, Government Facilities, Manufacturing Plants and more.

About Hempel

As a world-leading supplier of trusted coating solutions, Hempel is a global company with strong values, working with customers in the protective, marine, decorative, container and yacht industries. Hempel factories, R&D centers and stock points are established in every region.

Across the globe, Hempel's coatings protect surfaces, structures and equipment. They extend asset lifetimes, reduce maintenance costs and make homes and workplaces safer and more colorful. Hempel was founded in Copenhagen, Denmark in 1915. It is proudly owned by the Hempel Foundation, which ensures a solid economic base for the Hempel Group and supports cultural, social, humanitarian and scientific purposes around the world.

Hempel (USA) Inc
2728 Empire Central,
Dallas, TX 75235
Tel: +1 (214) 353-1600

Neogard.com

US_V2_MAR_20